

hotset

Operating Instructions

Single Loop Temperature Controller

hotcontrol C248

hotcontrol C296



CE

Rev. 1.00.08
05/2017

Translation of original
operating instructions

Quick start-up

The temperature controller is ready for use. One control zone for one heater and one thermocouple for measurement of the actual value is set up for operation. The start-up of the control zone can be done in a few steps. (*) see chapter ↗Display Loc)

C248

Step 1: Electrical connection

- Connect the thermocouple between terminal 10 and 11.
- A Solid State Relay (SSR) is used as a power controller. Notice the heat output at switching to select the correct SSR.
To activate the Solid State Relay connect it to terminal 5(+) and 6(-) of the controller.
- Connect the heater with power supply and Solid State Relay. Use ultra rapid micro-fuse or ultra rapid automatic circuit breaker for fuse protection of the heating circuit.
- Connect the power supply of the controller by terminal 1 and 2 (e.g. 230 VAC).



Notice necessarily the specification of the power supply of the controller (85...250 VAC or 24 V)! Provide fuse protection.

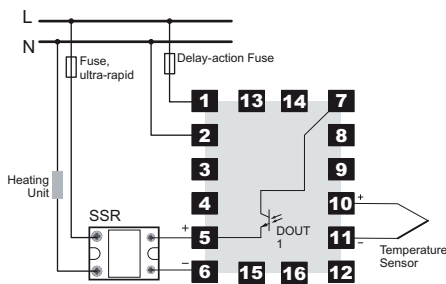

Step 2: Adjust sensor type *)

- Press button **P** repeatedly until **SEn** is shown in the display.
- Choose sensor type with the buttons **↑** or **↓**.
- Confirm sensor type with **P** and return to actual/set point value display with **ESC**.

Step 3: Adjust set point *)

- Press button **ESC** repeatedly until **SP** is shown in the display.
- Press **P** and change set point with **↑** and **↓**.
- Confirm set point entry with button **P** and return with **↑** or **↓** to actual/set point value display.

C296

Step 1: Electrical connection

- Connect the thermocouple between terminal 10 and 11.
- A Solid State Relay (SSR) is used as a power controller. Notice the heat output at switching to select the correct SSR.
To activate the Solid State Relay connect it to terminal 17(+) and 24(-) of the controller.



For the power supply of the control output there must be an additional connection between terminal 1 and 16.

- Connect the heater with power supply and Solid State Relay. Use ultra rapid micro-fuse or ultra rapid automatic circuit breaker for fuse protection of the heating circuit.
- Connect the power supply of the controller by terminal 13 and 14 (e.g. 230 VAC)



Notice necessarily the specification of the power supply of the controller (85...250 VAC or 24 V)! Provide fuse protection.

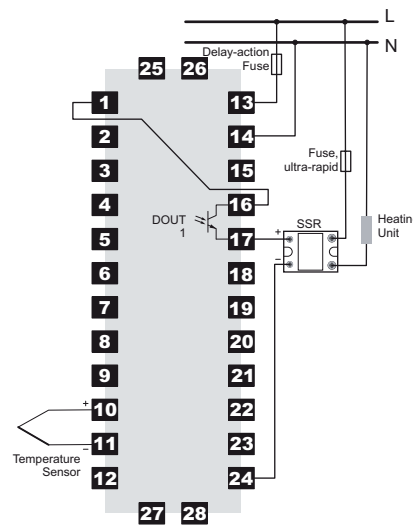

Step 2: Adjust sensor type *)

- Press button **P** repeatedly until **SEn** is shown in the display.
- Choose sensor type with the buttons **↑** or **↓**.
- Confirm sensor type with **P** and return to actual/set point value display with **ESC**.

Step 3: Adjust set point *)

- Press button **ESC** repeatedly until **SP** is shown in the display.
- Press **P** and change set point with **↑** and **↓**.
- Confirm set point entry with button **P** and return with **↑** or **↓** to actual/set point value display.

1 Introduction	4
2 Warranty Conditions	4
3 Installation and safety references	5
4 Installation and Start-up	6
Scope of supply	6
Equipment implementation/Ordering designations	6
Type plate	6
Type designation	7
Mounting and Housing	8
Exchange of Controller	10
Electrical Connection and Base Configuration	10
Connection overview	10
Standard Equipment	11
Power supply	11
Sensor-/measurement inputs	11
Digital outputs	12
Digital inputs	12
Heating Current Monitoring	13
Options	13
Serial Interface RS485 (2-wire) (Option A)	13
Serial Interface RS485 (4-wire) (Option A and B)	14
CAN-Bus (Option B)	14
Analog Outputs (Option A and B)	14
Digital in-/outputs (Option A and B)	15
5 Display and Operation	17
Front view	17
Display Loc	17
Display of Examples of Operation	18
Display of Buttons	18
Display of LED	18
Steps of Operation in Flow-Chart	18
Operation Levels	19
Direct data entry of set point and degree of operation	20
Information Level	20
User Level	22
System Level	22
Two Methods of Data Entry at User and System Level	23
Unblocking of Parameters at User Level	23
Additional Operating Functions	24
Enter Code Number	24
Software Version / Period of Operation	25
Activate Input block on User -/System Level	25
Messages & Displays	26
Status Messages	26
6 Configuration / Setting	28
Main functions	28
Control parameter	30
Group functions	32
Definition of Temperature Limit Values	32
Configuration of Base functions	32

Display	33
Configuration of Hardware	33
Configuration of Alarm Flags	37
Definition of Timers	38
Configuration of Operation	39
Configuration of Data Interface	40
Basic settings for Special Applications	40
Application Hot Runner Control	40
Application Extrusion	41
Application Hot Air	41
Alarm Hysteresis Function	41
7 Appendix	42
Parameters/factory delivery status	42
Firmware update	45
Version History	48

1 Introduction

The compact controller models C248 and C296 are one zone temperature controllers (dimensions 48x48mm and 48x96mm) with adaptive parameter adjustment. They are applicable for all purpose applications in extremely fast to extremely slow zones.

The controllers are available in different specifications. This has to be considered at installation and start-up. For details please refer to chapter ↗Equipment implementation/Ordering designations as well as ↗Configuration / Setting.

These operating instructions assist in case of first installation and start-up of the controller as well as in case of changes and adjustment of an existing control system. Status and error messages are described and remedies are recommended for elimination of faults.

Protocol specifications of the serial interface and CAN-Bus are not integral part of the operating instructions. The specifications are available on request.

Symbols and explanation



Caution

In case of non-compliance with or inaccurate compliance there can result damage to the device or injuries to persons.



Note

Attention is drawn to a special feature.



Example

Function is explained by an example.



After June 2014 the design of the Info button / Escape button was changed (before June 2014 an „i“ was shown in a circle).

2 Warranty Conditions

This product is subject to the legal warranty time periods for faults or deficiencies in manufacture.

Content of Warranty

If a malfunction relatively occurs through the manufacture, Hotset GmbH repairs or replaces the nonconforming product, according to their own discretion.

The following repairs do not fall under the warranty and are liable to costs:

- Malfunctions after the legal notice periods have expired.
- Malfunctions caused through operating error of the user (if the device is not operated as described in the manual).
- Malfunctions caused through other devices.
- Changes or damage to the device which do not originate from the manufacturer.

If you wish to use services within the framework of this guarantee, please refer to Hotset GmbH.

3 Installation and safety references



Before installation, handling or operation of the device, please read through this operating instructions completely and carefully.

This controller fulfils the European Directives of security and EMC. It is the responsibility of the operator to observe the directives at installation of the device.

CE marking

The device complies with the European Directives for electromagnetic compatibility (complies with EN 61326-1) and low voltages (complies with EN 61010-1).

Service and repair

This device is maintenance free.

If the controller should indicate a fault, please contact Hotset GmbH. Customer repairs are not permissible.

Cleaning

Employ no water or cleaning agents based on water for the cleaning of the device stick-on labels. You can clean the surface of the devices with a mild soap solution.

Storage

If you should not put the device into operation immediately after unpacking, protect it against moisture and coarse dirt.

Personnel

The installation of the device may be carried out by qualified personnel only.

Wiring

The wiring system must be implemented correctly according to the specifications in this operating manual. All feeds and connecting terminals must be dimensioned for the corresponding amperage. Furthermore, all connections are to be carried out according to the valid VDE Specification and/or the respective national specifications.



Ensure in particular that the AC power supply is not connected with the logic output or the low-voltage input.

Overload protection

For the power supply of the controller and the controller outputs use a fuse protection or a circuit breaker. That protects the printed circuit board against overload.

Maximum Voltage for Devices with Power Supply of 85...250VAC

For controllers with a power supply of 85...250VAC the maximum applied voltage on the terminals has to be less than 250 VAC.

DO NOT connect the controller to three phase systems or grounded midpoints. In case of an error the voltage of the power supply can exceed 250 VAC. Under these circumstances the device is not reliable.

Voltage transients on power supply terminals and between power supply and ground should not exceed 2.5 kV. For transients expect to exceed 2.5 kV, the power supply voltage should be limited to 2.5 kV by an over voltage protection.

Environment

Conducting contamination must not reach the proximity of the device connecting terminals in the control cabinet. In order to achieve suitable ambient air conditions, install an air filter in the air inlet of the control cabinet. If the controller should be in a condensing environment (low temperatures), install a thermostat-controlled heating unit in the control cabinet.

4 Installation and Start-up

4.1 Scope of supply



The controller is packed in a robust cardboard box. Check the packaging and then the temperature controller for identifiable damage incurred during transit. If damage is identified, then please get in touch with the transportation company.



In case of damage DO NOT put the controller into operation.



Two securing brackets (see figure) and the operating instructions are included in the box.

4.2 Equipment implementation/Ordering designations

When ordering the controller it is important to specify what options are required (refer to). The exact specification can be read on the type plate on the cardboard box, the controller housing and the printed circuit board.



Type plate on cardboard box



Type plate on controller housing



Type plate on printed circuit board

4.2.1 Type plate

The following information can be taken from the type plate:



- 1 ↗Type designation
- 2 Revision identification of the printed circuit boards
- 3 Revision identification of the controller software
- 4 Order number
- 5 Serial number

4.2.2 Type designation

The type designation specifies the controller model and consists of the following options.

Controller Type	C248		C296	
Input A	TCPT	Thermocouple/Pt100	TCPT	Thermocouple/Pt100
Input B	-	-	U	0/2...10VDC
Input C	-	-	I	0/4...20mA
Digital output 1	TS	Optical coupler	TS	Optical coupler
Digital output 2	TS R	Optical coupler Relay	TS R	Optical coupler Relay
Digital output 3	-	-	TS R	Optical coupler Relay
Digital output 4	-	-	TS R	Optical coupler Relay
Option A	- RS 485 U I DIO RS485 T	Not existing Serial interface (2-wire) Analog output 0/2...10VDC Analog output 0/4...20mA Digital inputs/outputs Serial interface (4-wire)*	- RS 485 U I DIO RS485 T	Not existing Serial interface (2-wire) Analog output 0/2...10VDC Analog output 0/4...20mA Digital inputs/outputs Serial interface (4-wire)*
Option B	- CAN U I DIO RS 485 R	Not existing CAN interface Analog output 0/2...10VDC Analog output 0/4...20mA Digital inputs/outputs Serial interface (4-wire)*	- CAN U I DIO RS 485 R	Not existing CAN interface Analog output 0/2...10VDC Analog output 0/4...20mA Digital inputs/outputs Serial interface (4-wire)*
Voltage	230 VAC 24 V	85...250 VAC 24 VAC/DC	230 VAC 24 V	85...250 VAC 24 VAC/DC

* RS485 4-wire only possible for option A = RS485T and option B = RS485R.

4.3 Mounting and Housing

The control panel cut out has to be prepared according to the following sketch:

C248

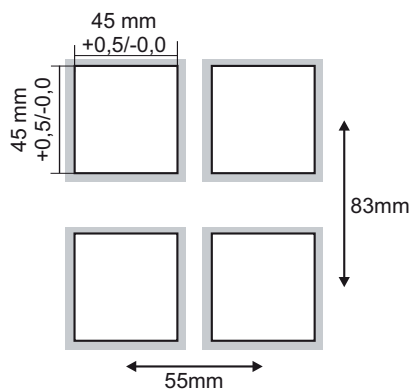

C296

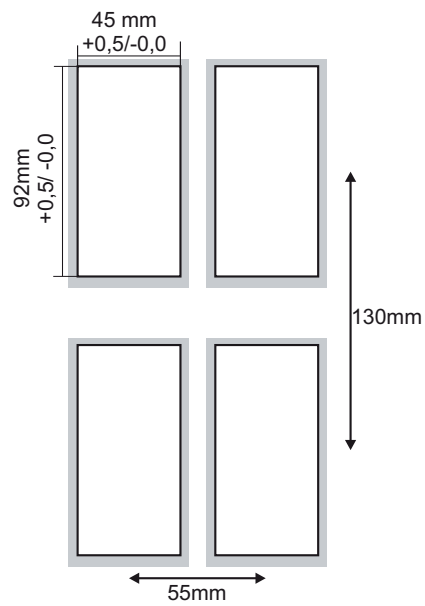

When fitting more than one controller in a control panel the correct spacing of the controllers is necessary. A spacing of 10mm in horizontal, and 38mm in vertical direction is recommended.

The controllers C248 and C296 are equipped with a straightforward mounting system. The housing can be mounted / removed without any tools.

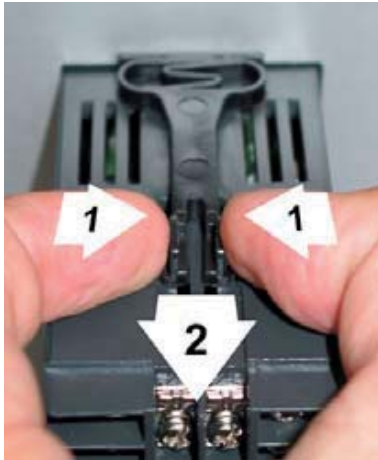

To mount the controller, remove the securing brackets. Press the securing brackets at the end (1), move it backward (2) out of the guides.



Pass the controller into the front side of the control panel cut out or remove it from the front side.

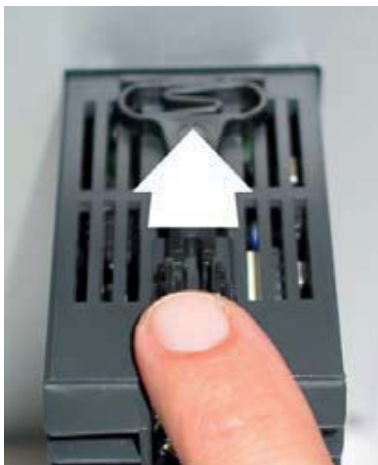

Refit the securing brackets into the guides again and push it forward.

4.4 Exchange of Controller

For an exchange of a controller the housing need not to be removed.



Press the lock at the lower end of the front side and remove the controller from the housing (see figure).



Only controllers of the same type should be exchanged. Notice to take over the setting of the controller.

4.5 Electrical Connection and Base Configuration



The controller may be installed and put into operation by specialist personnel only.

Before switch-on of the control zones it is to be ensured that the controller is configured for the application. An incorrect configuration can lead to damage to the control section or to injuries to persons.

The wiring system is implemented on the screwed terminals on the rear side with the appropriate cable lugs. Cables with a cross section of 0.5 to 1.5mm² can be employed.

The start-up of the controller includes the electrical installation as well as the correct configuration. Succeeding the terminal allocation and instructions are given in detail.

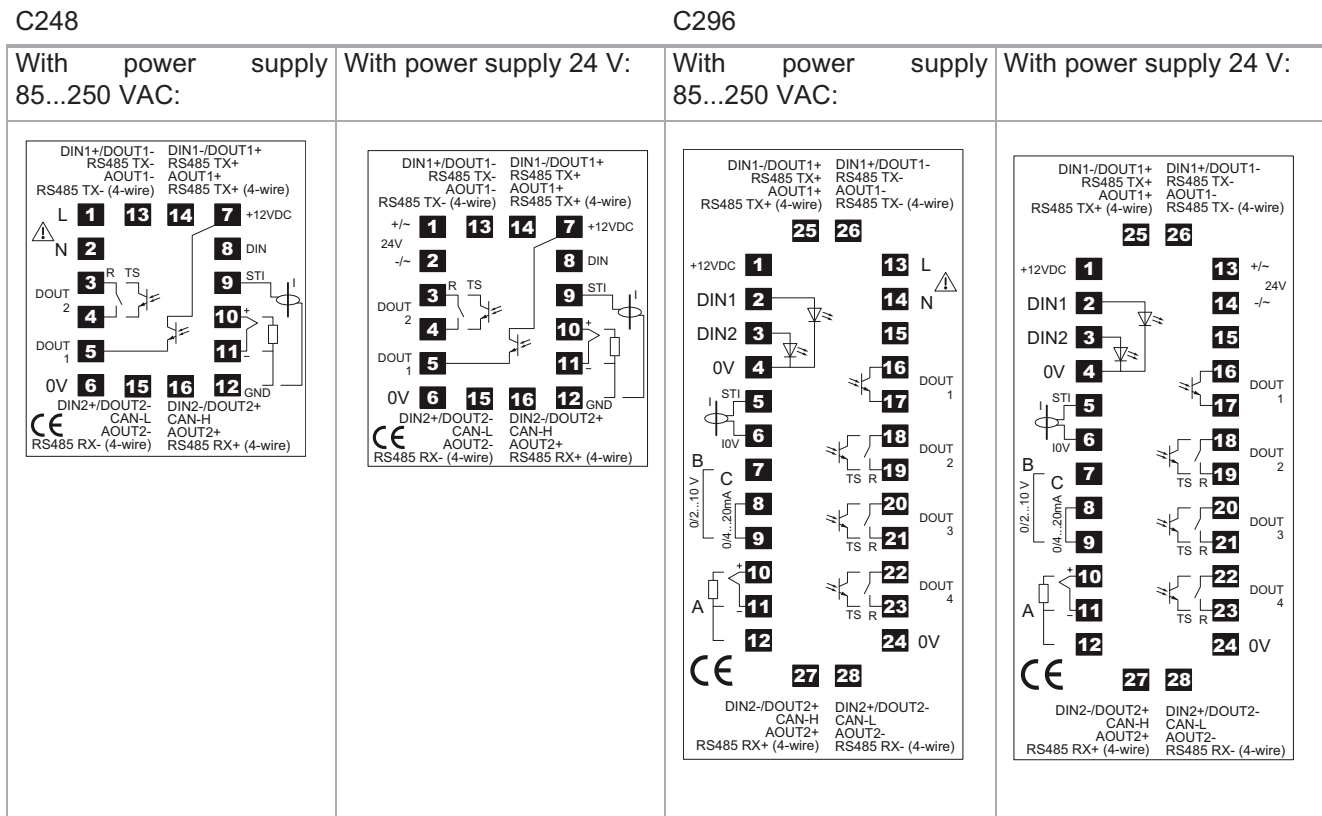

4.5.1 Connection overview

The terminal overview is glued on one side of the controller next to the type plate. All feasible connections are drawn in. Only controller configured variants can be used.



4.5.2 Standard Equipment

4.5.2.1 Power supply

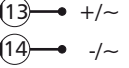
Controller Type	C248	C248	C296	C296
Power supply	230 VAC	24 V	230 VAC	24 V
Range	85...250 VAC	18...24 VAC or 18...36 VDC	85...250 VAC	18...24 VAC or 18...36 VDC
				
Power consumption	6.5W	6.5W	6.5W	6.5W
Fuse	200mA time lag	800mA time lag	200mA time lag	800mA time lag

Fuse protection of the controller always externally.

4.5.2.2 Sensor/measurement inputs



Compared to C248 with one measuring input, C296 has three measuring inputs. It can be selected which of these three measuring inputs or which combination of these is used as actual value.

Furthermore the presetting of the set point for C296 can be done by measuring input additional to entry by keypad or data interface.

C248

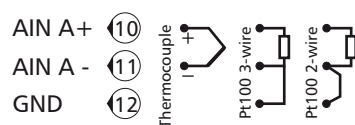

C296

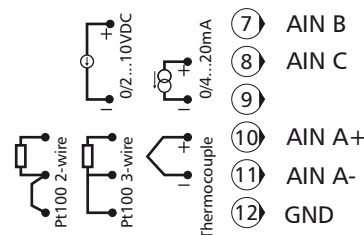

Configuration

Define measuring input A	<ul style="list-style-type: none"> Page35: [P072]SEn - Sensor Type of Measuring Input A Page37: [P075]oFF.A - Offset of Measuring Input A
Define measuring input B and C (only C296)	<ul style="list-style-type: none"> Page37: [P078]Aib.L - Lower Display Limit of Measuring Input B Page37: [P079]Aib.H - Upper Display Limit of Measuring Input B Page37: [P080]AiC.L - Lower Display Limit of Measuring Input C Page37: [P081]AiC.H - Upper Display Limit of Measuring Input C
Define function for measuring inputs (only C296)	<ul style="list-style-type: none"> Page35: [P073]SEn.C - Measuring Input for Control Page37: [P074]Sen.S - Measuring Input for Presetting of Set Point
Define input range for set point	<ul style="list-style-type: none"> Page33: [P051]SP.Lo - Lower Set Point Limit Page33: [P052]SP.Hi - Upper Set Point Limit

4.5.2.3 Digital outputs

C248

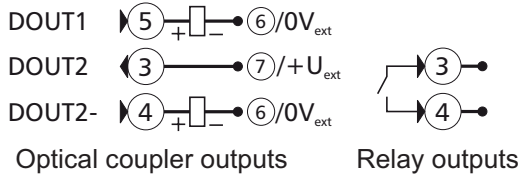

C296

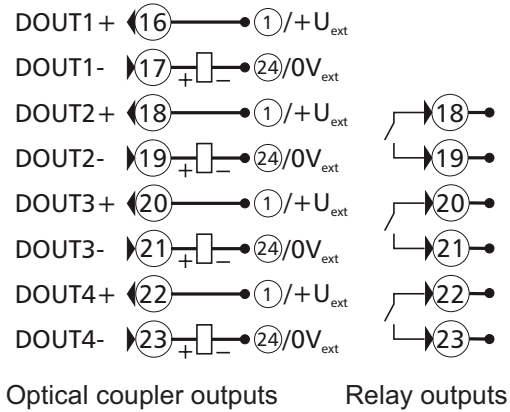

The power supply of DOUT1 is controller internally already wired.

As power supply for the outputs of the optical couplers either the controller internal voltage or an external d.c. voltage (24 VDC) can be used.

The controller outputs are according to the type designation.

Configuration

Which output on digital outputs?	<ul style="list-style-type: none"> Page33: [P058]dO.1 - Mode of Operation of Digital Output 1 to Page34: [P061]dO.4 - Mode of Operation of Digital Output 4
Is a relay connected to the control output heating or cooling?	<ul style="list-style-type: none"> Page33: [P049]rEL.H - Relay Output Heating Page33: [P050]rEL.C - Relay Output Cooling
Is control output used for output of alarm?	<ul style="list-style-type: none"> Page37: [P082]A1.d1 - Alarm Flag 1, Definition 1 to Page38: [P089]A4.d2 - Alarm Flag 4, Definition 2
Additional setting if output is used for output of temperature limit alarms	<p>Define alarm limits</p> <ul style="list-style-type: none"> Page28: [P007]Li.1 - Temperature Limit 1 to Page28: [P010]Li.4 - Temperature Limit 4 <p>Define mode of operation of alarm limits</p> <ul style="list-style-type: none"> Page32: [P041]Li.1d - Definition of Temperature Limit 1 to Page32: [P044]Li.4d - Definition of Temperature Limit 4 Page32: [P044]Li.4d - Definition of Temperature Limit 4

4.5.2.4 Digital inputs

C248

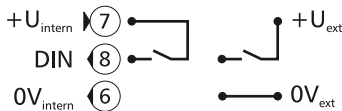

C296

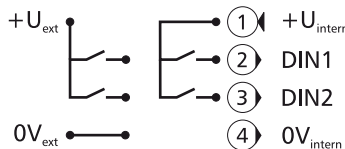

As power supply either the controller internal voltage or an external d.c. voltage (24 VDC) can be used.

Configuration

Define mode of operation of digital inputs.	<ul style="list-style-type: none"> Page34: [P062]dIn.1 - Mode of Operation of Digital Input 1 Page34: [P063]dIn.2 - Mode of Operation of Digital Input 2
Is digital input used to activate a set point?	<p>Define set point</p> <ul style="list-style-type: none"> Page28: [P011]SP.2 - Set Point 2 to Page29: [P013]SP.4 - Set Point 4

Setting if digital input is used to start a timer	Define duration of timer <ul style="list-style-type: none"> Page29: [P017]t1 - Process Timer 1 to Page30: [P020]t4 - Process Timer 4 Define mode of operation of timer <ul style="list-style-type: none"> Page38: [P090]t1.d1 - Mode of Operation of Timer 1, Definition 1 to Page39: [P097]t4.d2 - Mode of Operation of Timer 4, Definition 2 Define mode of operation of timer in case of disturbance <ul style="list-style-type: none"> Page39: [P098]t.rES - Mode of Operation of Timer after Soft-Reset
---	---

4.5.2.5 Heating Current Monitoring

C248

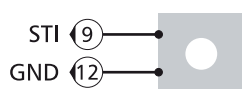

C296



Do only use current transformers available in the accessories by Hotset GmbH.

Configuration

Define measuring method.	<ul style="list-style-type: none"> Page33: [P053]Cur.d - Current Supervision Function
Define upper limit of measurement range.	<ul style="list-style-type: none"> Page33: [P054]Cur.E - Final Value of Measurement Range of Current Supervision
Define heating current and tolerance	<ul style="list-style-type: none"> Set point of current either directly entered: Page28: [P004]Cur.S - Set Point of Heater Current or by automatic current transfer Page20: Information Level Page28: [P005]Cur.t - Tolerance Band of Heater Current

4.5.3 Options

In addition to the standard equipment the controller can be equipped with two options (Option A and B).

4.5.3.1 Serial Interface RS485 (2-wire) (Option A)

C248

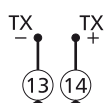

C296

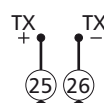

The RS485 connection admits to communicate with 32 controllers by PC over a great distance. A shielded wire has to be used.

Configuration

Define option	<ul style="list-style-type: none"> Page34: [P064]OPt.A - Definition of Option A define as rS
Define communication protocol	<ul style="list-style-type: none"> Page40: [P102]S.Pro - Protocol of Serial Interface
Define setting of interface	<ul style="list-style-type: none"> Page40: [P101]S.Adr - Address of serial interface Page40: [P103]S.bd - Baud Rate of Serial Interface Page40: [P104]S.Sto - Stop Bits of Serial Interface Page40: [P105]S.PAr - Parity of Serial Interface
Additional setting if communication protocol is in mode MODBUS	<ul style="list-style-type: none"> Page40: [P109]m.Adr - MODBUS address

4.5.3.2 Serial Interface RS485 (4-wire) (Option A and B)



RS485 4-wire only possible for option A = RS485T and option B = RS485R.

Configuration

Define option	<ul style="list-style-type: none"> Page34: [P064]OPT.A - Definition of Option A define as rS Page35: [P065]OPT.b - Definition of Option B define as rS
Define communication protocol	<ul style="list-style-type: none"> Page40: [P102]S.Pro - Protocol of Serial Interface
Define setting of interface	<ul style="list-style-type: none"> Page40: [P101]S.Adr - Address of serial interface Page40: [P103]S.bd - Baud Rate of Serial Interface Page40: [P104]S.Sto - Stop Bits of Serial Interface Page40: [P105]S.PAr - Parity of Serial Interface
Additional setting if communication protocol is in mode MODBUS	<ul style="list-style-type: none"> Page40: [P109]m.Adr - MODBUS address

4.5.3.3 CAN-Bus (Option B)



Up to 127 controllers can be connected by CAN-Bus. Beside the communication with a superior control/visualiza--tion system the remote control function is feasible. For more detailed information please refer to ↗Configuration of Data Interface.

Configuration

Define option	<ul style="list-style-type: none"> Page35: [P065]OPT.b - Definition of Option B define as CAN
Define setting of interface	<ul style="list-style-type: none"> Page40: [P106]C.bAS - CAN base address Page40: [P107]C.bd - CAN baud rate Page40: [P108]C.OP - CAN Auto Operational Mode

4.5.3.4 Analog Outputs (Option A and B)



Both options of the controller can be of the analog output type.

Configuration

Define option	<ul style="list-style-type: none"> Page34: [P064]OPT.A - Definition of Option A and Page35: [P065]OPT.b - Definition of Option B define as AO or AO.O
---------------	--

Stipulate function of the analog outputs.	<ul style="list-style-type: none"> Page35: [P070]AO.A - Mode of Operation of Analog Output Option A and Page35: [P071]AO.b - Mode of Operation of Analog Output Option B
---	--

4.5.3.5 Digital in-/outputs (Option A and B)

C248

Digital outputs

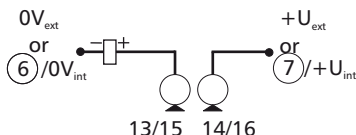

Digital inputs

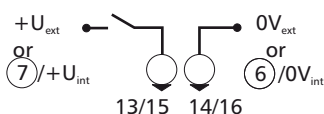

C296

Digital outputs



Digital inputs

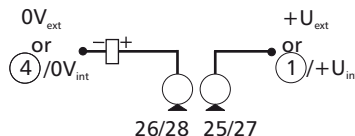

Configuration

Define option	<ul style="list-style-type: none"> Page34: [P064]OPt.A - Definition of Option A and Page35: [P065]OPt.b - Definition of Option B define as dl or dO
---------------	---

Option digital output **dO** is defined:

Define mode of operation of digital output.	<ul style="list-style-type: none"> Page35: [P066]dO.A - Mode of Operation of Digital Output Option A and Page35: [P067]dO.b - Mode of Operation of Digital Output Option B
Is control output used for output of heating or cooling?	<ul style="list-style-type: none"> Page33: [P049]rEL.H - Relay Output Heating Page33: [P050]rEL.C - Relay Output Cooling
Is control output used for output of alarm?	<ul style="list-style-type: none"> Page37: [P082]A1.d1 - Alarm Flag 1, Definition 1 to Page38: [P089]A4.d2 - Alarm Flag 4, Definition 2
Additional setting if output is used for output of temperature limit alarms	<p>Define alarm limits</p> <ul style="list-style-type: none"> Page28: [P007]Li.1 - Temperature Limit 1 to Page28: [P010]Li.4 - Temperature Limit 4 <p>Define mode of operation of alarm limits</p> <ul style="list-style-type: none"> Page32: [P041]Li.1d - Definition of Temperature Limit 1 to Page32: [P044]Li.4d - Definition of Temperature Limit 4 Page32: [P044]Li.4d - Definition of Temperature Limit 4

Option digital input **dl** is defined:

Define mode of operation of digital input	<ul style="list-style-type: none"> Page35: [P068]dlIn.A - Mode of Operation of Digital Input Option A and Page35: [P069]dlIn.b - Mode of Operation of Digital Input Option B
Is digital input used to activate a set point?	<p>Define set point</p> <ul style="list-style-type: none"> Page28: [P011]SP.2 - Set Point 2 to Page29: [P013]SP.4 - Set Point 4

Setting if digital input is used to start a timer	<p>Define duration of timer</p> <ul style="list-style-type: none">■ Page29: <i>[P017]t1 - Process Timer 1</i> to Page30: <i>[P020]t4 - Process Timer 4</i> <p>Define mode of operation of timer</p> <ul style="list-style-type: none">■ Page38: <i>[P090]t1.d1 - Mode of Operation of Timer 1, Definition 1</i> to Page39: <i>[P097]t4.d2 - Mode of Operation of Timer 4, Definition 2</i> <p>Define mode of operation of timer in case of disturbance</p> <ul style="list-style-type: none">■ Page39: <i>[P098]t.rES - Mode of Operation of Timer after Soft-Reset</i>
---	---

5 Display and Operation

5.1 Front view

C248

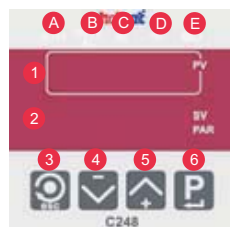

C296



Before 2014	July 2014	Blue front foil	Blue front foil
LED displays	1	Actual value / Parameter value	Actual value / Parameter value
	2	Set point / Parameter name	Set point / Parameter name
Buttons	3	Info button / Escape button	Info button / Escape button
	4	Decrease button	Decrease button
	5	Increase button	Increase button
	6	Parameter button / Edit Enter button	Parameter button / Edit Enter button
LEDs	A	Output heating	Digital input 1 activated
	B	Output cooling / alarm output 3 *)	Digital output 2 activated
	C	Digital input activated	Temperature unit °F
	D	Temperature unit °F	Output heating
	E	Communication RS485/CAN-Bus	Output cooling / alarm output 3 *)
	F	-	Alarm 1
	G	-	Alarm 2
	H	-	Communication RS485/CAN-Bus

*) see ↗[P087]A3.d2 - Alarm Flag 3, Definition 2 (page 38)

5.1.1 Display Loc

Is **Loc** displayed in the actual value display; an input blocking is active.



See setting of parameter ↗[P100]iLoc - Entry Lock on Info Level (page 40) and chapter ↗Two Methods of Data Entry at User and System Level (page 23).

See setting of parameter ↗[P110]ULoc - Entry Lock on User/System level (page 40) and chapter ↗Activate Input block on User -/System Level (page 25).

5.2 Display of Examples of Operation

Display of Buttons

To illustrate the operation the symbols have the following meaning:





Press button





Keep the button pressed



Shortcut: Keep button  pressed and press button  additionally



Shortcut: First keep button  pressed, then keep button  additionally pressed



Press button  or button .

Display of LED



The display of actual value / set point is in gray color for a better identification. All other LED displays have a black background.



Display, when set point or one parameter value is flashing.

Steps of Operation in Flow-Chart

All steps of operation are explained by flow-charts. In the flow-charts the display as well as the buttons are shown in combination.

Please follow the arrows in the flow-chart to comprehend the steps of operation.



5.3 Operation Levels

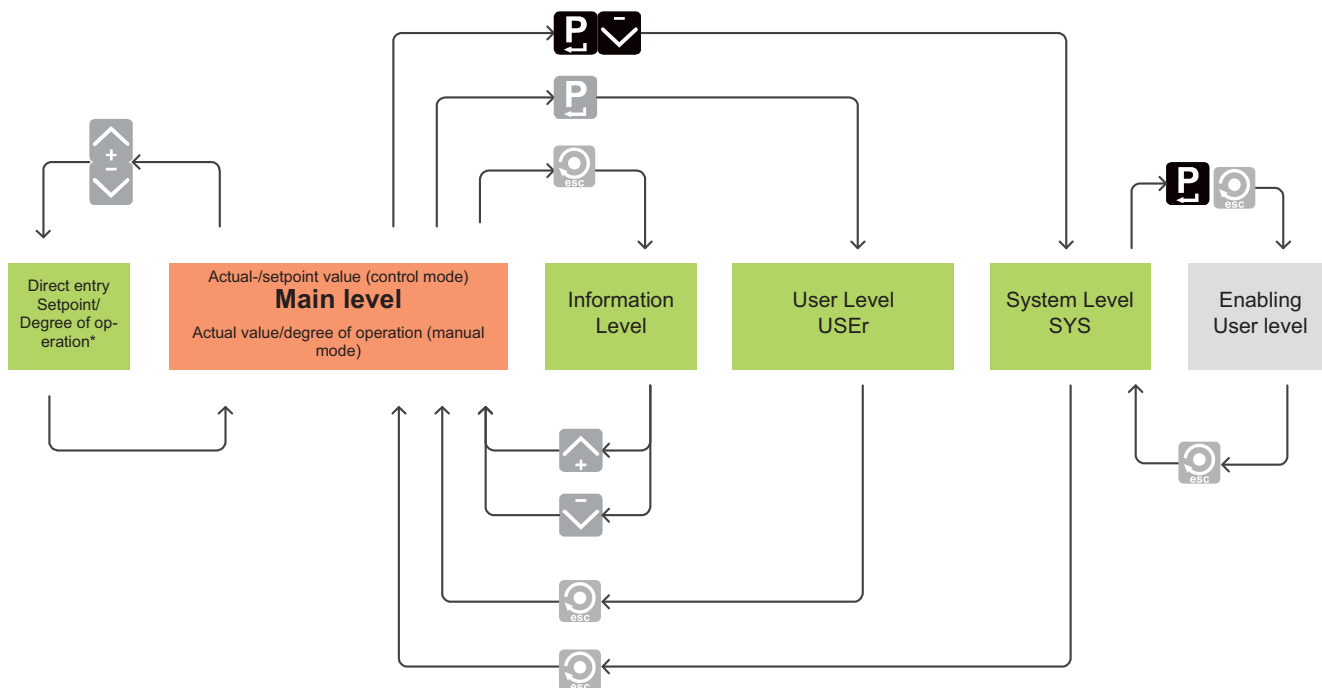

Beside the direct data entry the operation and configuration of the controller takes place in 3 sublevels starting from the main level:



* Direct data entry of set point and degree of operation	Direct data entry of set point (the controller is in control mode) and degree of operation (the controller is in manual mode) only for \nearrow [P099]Edit - Entry Mode Directly (page 39) = on.
Main level	In the main level actual value and set point and actual value and degree of operation respectively are displayed.
Information Level	Display and operation of the often used process parameters (set point, manual mode, heating current, alarm). Is Loc displayed in the actual value display; see chapter \nearrow Display Loc (page 17).
User Level USER	Display and operation of parameters that are occasionally displayed and changed. The list of parameters can be arranged individually. Is Loc displayed in the actual value display; see chapter \nearrow Display Loc (page 17).
System Level SYS	Display and operation of <i>all</i> parameters. Unblocking at user level: Additionally to the parameter value each parameter has an unblock information at user level. This defines the status of the parameter at user level: <ul style="list-style-type: none"> ▪ hidden ▪ visible/not changeable or ▪ visible/changeable. The display at user level can individually be arranged for the application. Is Loc displayed in the actual value display; see chapter \nearrow Display Loc (page 17).

5.3.1 Direct data entry of set point and degree of operation

In the direct data entry mode the set point and the degree of operation are directly changed by pressing the buttons  or .

- At direct data entry the data entry is accepted three seconds after the last entry.
- The data entry is accepted immediately after pressing the button .
- Pressing the button  within the three seconds the data entry is canceled.

The program returns to main level and displays actual value/set point and actual value/degree of operation re-spectively.

Is **Loc** displayed in the actual value display; see chapter ↗Display Loc (page 17).

5.3.2 Information Level

In the information level set point, manual mode, heating current and alarms are directly accessible by button .

At information level

- set points for temperature can be changed,
- manual mode can be switch on/off and degree of operation can be adjusted,
- an automatic current transfer can be made as well as
- display of alarms and acknowledgement

Is **Loc** displayed in the actual value display; see chapter ↗Display Loc (page 17).

5.3.3 User Level

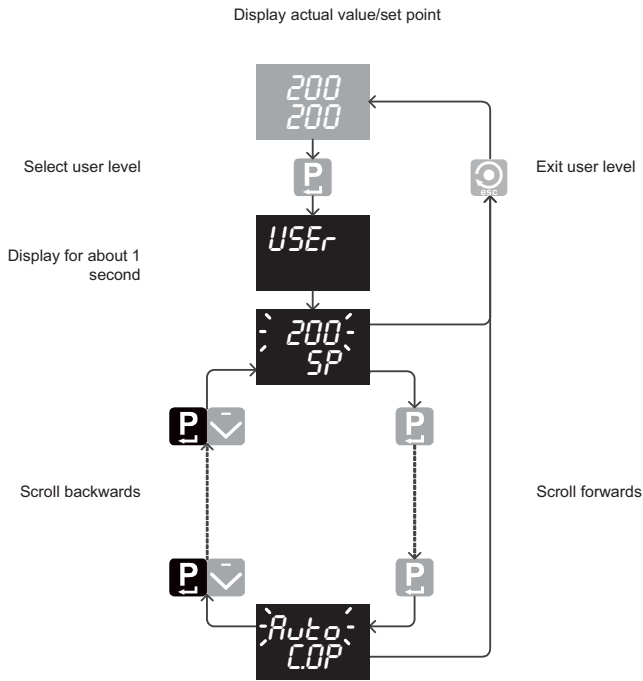

- By call of user level USER is shortly shown in the LED display.
 - In the user level it is feasible to scroll forward and back-ward between the parameters.
 - It depends on the unblocking (↗Unblocking of Parameters at User Level (page 23)), which parameters at the user level are visible and changeable too.
- The user level can always be left by button  to return to actual value / set point display.

Is **Loc** displayed in the actual value display; see chapter ↗Display Loc (page 17).

5.3.4 System Level

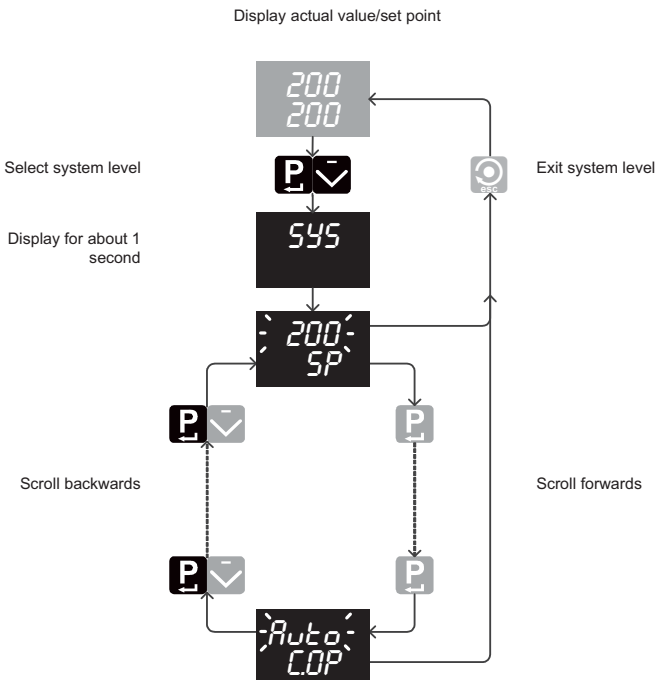

- By call of system level SYS is shortly shown in the LED display.
 - In the system level it is feasible to scroll forward and backward between the parameters
- The system level can always be left by button  to return to actual value / set point display.

Is **Loc** displayed in the actual value display; see chapter ↗Display Loc (page 17).

5.3.5 Two Methods of Data Entry at User and System Level

It can be chosen between two methods of data entry for parameters at user and system level. The method of data entry is defined by the parameter ↗[P099]Edit - Entry Mode Directly (page 39).

The difference between the two methods is shown by the example of a change of a set point at user level.

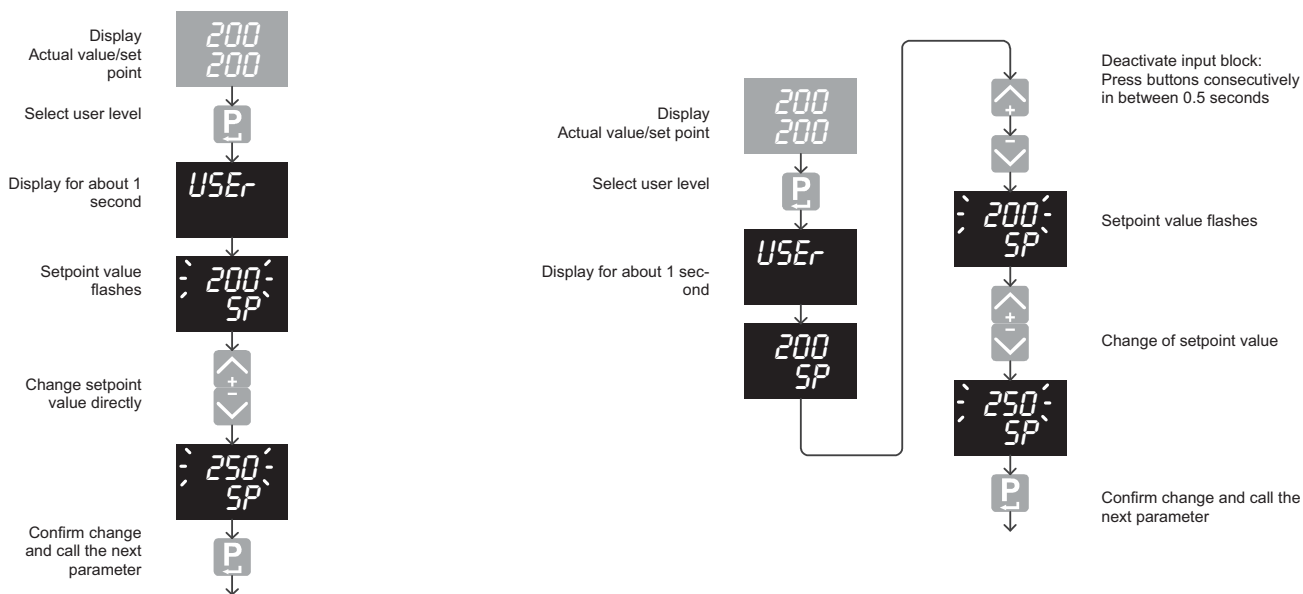

Direct Data Entry (Edit = on)

The set point can be entered directly after selection. Unblocking is not necessary.

Unblock Data Entry (Edit = off)

Before data entry the input blocking must be enabled at user level. The input blocking is an additional step to prevent unintentional parameter changes which are feasible by the direct data entry.

Is **Loc** displayed in the actual value display; see chapter ↗Display Loc (page 17).

For input blocking also refer to ↗Enter Code Number (page 24).

5.3.6 Unblocking of Parameters at User Level

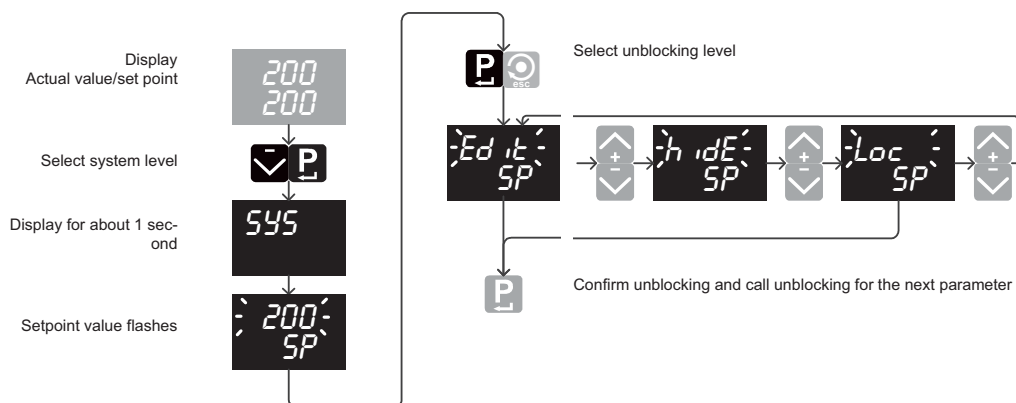

Is **Loc** displayed in the actual value display; see chapter ↗Display Loc (page 17).

For each parameter the unblocking defines whether the parameter is visible and changeable at user level. The display at user level can individually be arranged for the application.

	Parameter visible	Parameter changeable
<i>Edit</i>	yes	yes
<i>hidE</i>	no	no
<i>Loc</i>	yes	no

To return from unblocking to system level use button .

For factory-made settings concerning unblocking please refer to ↗Appendix (page 42).

5.4 Additional Operating Functions

5.4.1 Enter Code Number

Code numbers are used to call complex functions or system functions.

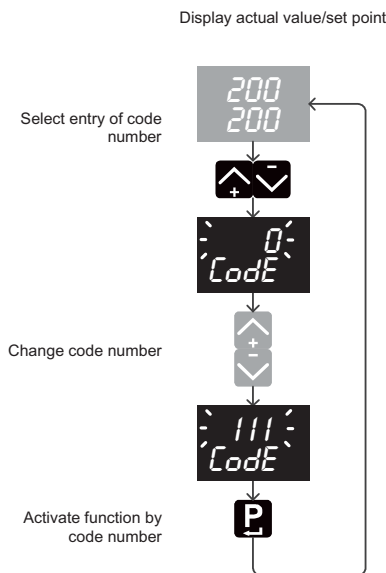

The following code numbers exist for this controller:

Code number	Function
1...100	Input blocking (see parameter ↗[P110]ULoc - Entry Lock on User/System level (page 40)) is temporarily released (1 minute after the last key operation activated again).
111	Start automatic identification cooling Prerequisite to start the function is that the zone is in a adjusted status.
211	Deactivate input block (see parameter ↗[P099>Edit - Entry Mode Directly (page 39))
212	Activate input block (see parameter ↗[P099>Edit - Entry Mode Directly (page 39)) All data entry, except set point data entry, is locked. The input blocking is fail-safe. By entry of code number 211 the data entry blocking is deactivated.
445	Stop identification heating The function that calculates the control parameters during heating is directly stopped.
999	Perform controller reset After activation of the code number the controller makes a new start.

5.4.2 Software Version / Period of Operation

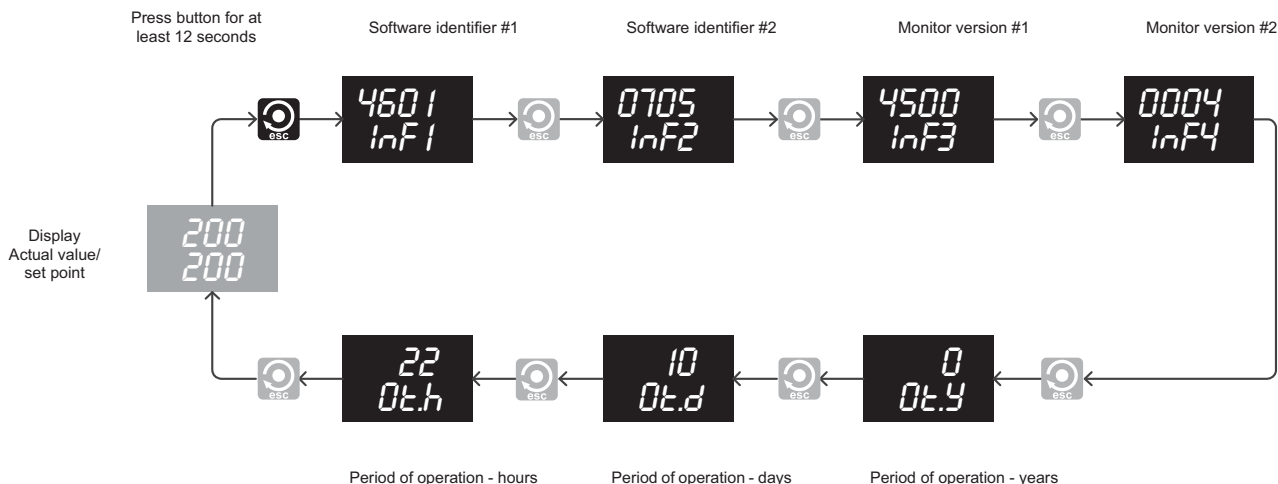

The display of software version and period of operation are only for reasons of maintenance. Please keep this data ready in case of queries for the controller at Hotset GmbH.



The firmware of the controller is of calendar week 07/2005 (software identification #2).

The period of operation is 10 days and 22 hours.

For software identifier #1 and the two monitor identifiers additional system information is available.

Exit dialog level by pressing button  or button .

5.4.3 Activate Input block on User -/System Level

The input on user level USER and on system level SYS can be blocked by parameter ↗[P110]ULoc - Entry Lock on User/System level (page 40).

This setting overrides the setting of parameter ↗[P099]Edit - Entry Mode Directly (page 39).

For setting of parameter ↗[P110]ULoc - Entry Lock on User/System level (page 40) > 0, i.e. blocking active, **Loc** is displayed in the actual value display.

After restart of the device, all data entry except setpoint value and degree of operation is automatically blocked.

Unblocking is done by entry of

↗[P110]ULoc - Entry Lock on User/System level (page 40)	for	User level USER
↗[P110]ULoc - Entry Lock on User/System level (page 40) + 10	for	System level SYS

as code number (see chapter ↗Enter Code Number (page 24)).

Input blocking is automatically reactivated 1 minute after the last key operation.

The setting of parameter ↗[P110]ULoc - Entry Lock on User/System level (page 40) = 0 deactivates the input block.

The setting of parameter ↗[P110]ULoc - Entry Lock on User/System level (page 40) is fail-safe.

5.5 Messages & Displays

5.5.1 Status Messages



Status messages in case of alarm status or certain operating status will be alternately displayed with the actual value as additional information.

Display	Meaning	Alarm	Status	Fault Correction
tCbr	Sensor break	x		Control thermocouple or wiring.
tCrC	Sensor incorrect polarity	x		Thermocouple wiring wrong. Correct wiring.
IdE	Identification error	x		Cool zone down and then start identification again.
drl	Temperature drift	x		Determination of heating control parameters can not start because the zone was influenced by another zone at identification. Start identification again.
Id	Identification heating		x	
IdC	Identification cooling		x	
IdS	Start up phase automatic adaptation of cooling		x	
mAnU	Manual mode		x	
AL	Measuring range exceeded (temperature alarm)	x		Control heating unit and power controller (e.g. SSR). Control if the sensor related with the heating unit is connected with the controller.
SSr	Current alarm heating off	x		Control power controller (e.g. SSR). Control if the current transformer related to the heating unit is connected with the controller.
tCSC	Sensor alarm	x		Control thermocouple wiring. Control parameter setting ↗[P023]tC.ti - Testing Period for Manual Short Circuit Supervision of Sensor (page 30) and ↗[P022]tC.AL - Autom. Short Circuit Supervision of Sensor (page 30).
rAmP	Ramp		x	
SP4	Setpoint Value 4		x	
SP3	Setpoint Value 3		x	
SP2	Setpoint Value 2		x	
Ar.	Automatic ramp slowest zone		x	
Ar	Automatic ramp		x	
ArE	Error automatic ramp		x	
ArE.	Error automatic ramp slowest zone		x	
Err1	Error in calibration data	x		Send controller to Hotset GmbH.
Err2	Error in attributes	x		Send controller to Hotset GmbH.
Err3	Error in channel data	x		Send controller to Hotset GmbH.

Display	Meaning	Alarm	Status	Fault Correction
HoFF	Actuator deactivated		x	

6 Configuration / Setting

The parameters for configuration and setting of the controller are functionally grouped.

It depends on the unblocking of a parameter whether it is visible and/or changeable. The unblocking is done on system level where all parameters are visible and changeable.



- The factory-made basic setting is marked with a bracket (e.g. [on]).
- For some parameters the value range exceeds the display range of the LED (9999 or 999.9). The complete value range is only adjustable via serial interface or CAN-Bus interface.
- Temperature parameters are specified in °C by default. They apply for °F as well.

6.1 Main functions

[P001]SP - Set Point

Value range: [0.0]...1500.0

At 0°C/32°F

- no control signal is generated (degree of operation 0%)
- the control algorithm is initialized
- no other alarm except the heating circuit alarm is supervised

The setting of the unit for a set point (°C or °F) is done by parameter ↗[P055]CELS - Temperature Unit (page 33).

[P002]mAnU - Manual Mode

on	Manual mode active In manual mode the control is deactivated. The manual entered actuating variable ↗[P003]Out - Degree of Operation (page 28) is sent to the control outputs. Manual mode for example is used in case of a defect at the sensor when there is no actual temperature value for control and the control function for the zone has to be maintained.
[oFF]	Controller is in control mode (manual mode deactivated).

[P003]Out - Degree of Operation

Value range: -100...100% [0%]

Actuating variable. In control mode calculated by the controller, in manual mode entered by the operator.

↪[P021]AmAn - Automatic Manual Mode

[P004]Cur.S - Set Point of Heater Current

Value range: [0.0]...999.0 A

The measured heater current is compared with the set point. The set point is manually or by automatic current transfer (↗Information Level (page 20)) entered.

[P005]Cur.t - Tolerance Band of Heater Current

Value range: 0...100% [20]

Tolerance band around ↗[P004]Cur.S - Set Point of Heater Current (page 28) for supervision of heating current.

[P006]ZonE - Status of Zone

Activation/Deactivation of zone.

oFF	Zone deactivated <ul style="list-style-type: none"> ▪ No control signal is generated (degree of operation 0%) ▪ The control algorithm is initialized ▪ No alarm supervision
[on]	Zone activated

[P007]Li.1 - Temperature Limit 1

Value range: -999.0...1500.0 [5]

The zone can be supervised by four temperature limit values.

With the four associated parameters ↗[P041]Li.1d - Definition of Temperature Limit 1 (page 32) to ↗[P044]Li.4d - Definition of Temperature Limit 4 (page 32) the function of the limit value is determined. ↗[P044]Li.4d - Definition of Temperature Limit 4 (page 32)

[P008]Li.2 - Temperature Limit 2

Value range: -999.0...1500.0 [-5]

↪[P007]Li.1 - Temperature Limit 1

[P009]Li.3 - Temperature Limit 3

Value range: -999.0...1500.0 [0]

↪[P007]Li.1 - Temperature Limit 1

[P010]Li.4 - Temperature Limit 4

Value range: -999.0...1500.0 [0]

↪[P007]Li.1 - Temperature Limit 1

[P011]SP.2 - Set Point 2

Value range: -999.0...1500.0 [0]

The second set point is activated by a digital input or by a timer.

The same prerequisites apply accordingly to ↗[P001]SP - Set Point (page 28).

[P012]SP.3 - Set Point 3

Value range: [0.0] ... 1500.0

↪[P011]SP.2 - Set Point 2

[P013]SP.4 - Set Point 4

Value range: [0.0] ... 1500.0

↪[P011]SP.2 - Set Point 2

[P014]rAP.t - Temperature Ramp

Value range: -999.0...999.0 °C/Minute [0]

Changes of the set point are not directly made but by the adjusted ramp value.

= 0	Temperature ramp deactivated
> 0	Temperature ramp at set point increase activated
< 0	Temperature ramp at set point increase and decrease activated

In the set point display the set point of the actual ramp is displayed.



In the following diagram a change of a set point from 50°C to 120°C with a temperature ramp of 10°C/Minute is shown.

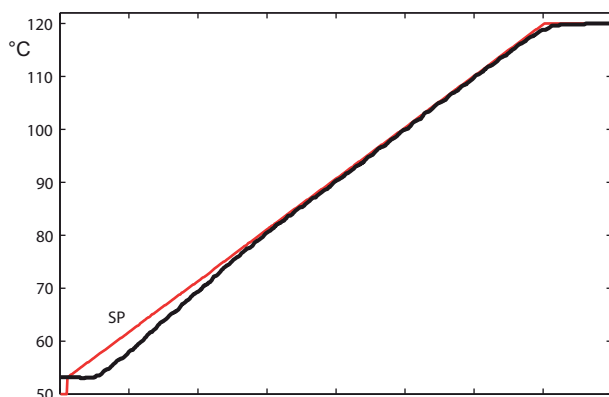

[P015]rAP.A - Automatic Temperature Ramp

[oFF]	Automatic ramp deactivated
on	<p>Consistent heating of several controllers.</p> <p>Prerequisites:</p> <ul style="list-style-type: none"> ■ Controller with CAN-Bus interface ■ Controller is connected with other controllers which should be heated consistent. The allocation is done by the group function. Controllers with the same <i>[P039]GP.nr - Group Number</i> are heated consistent during active automatic temperature ramp. <p>The automatic temperature ramp only works after the first change of the set point after switch-on of the controller. The zone with the slightest rate of rise of temperature is the leading zone and defines the set point of the ramp for all other zones. 15 K before reaching the set point the automatic temperature ramp is completed.</p> <p>The calculation of the control parameters by the function identification heating is not affected by the automatic temperature ramp.</p>

[P016]rAP.G - Temperature Band of Autom. Temperature Ramp

Value range: 2.0...25.5 K [5.0]

Maximal tolerable difference between actual value and set point of ramp during *[P015]rAP.A - Automatic Temperature Ramp*.

[P017]t1 - Process Timer 1

Value range: [0]...9999 seconds

Four timers are available to carry out a sequence of functions. The definition, how the timers operate, is determined by the parameters *[P090]t1.d1 - Mode of Operation of Timer 1, Definition 1* to *[P097]t4.d2 - Mode of Operation of Timer 4, Definition 2*.

[P018]t2 - Process Timer 2

Value range: [0]...9999 seconds

↪ *[P017]t1 - Process Timer 1*

[P019]t3 - Process Timer 3

Value range: [0]...9999 seconds

↪ *[P017]t1 - Process Timer 1*

[P020]t4 - Process Timer 4

Value range: [0]...9999 seconds

↪ [P017]t1 - Process Timer 1

[P021]AmAn - Automatic Manual Mode

on	Is an invalid measured value (due to sensor break) detected during control mode, the controller switches automatically over to manual mode. The last averaged degree of operation determined by the controller is used as the new degree of operation.
[oFF]	Function deactivated

[P022]tC.AL - Autom. Short Circuit Supervision of Sensor

on	<p>The function supervises the status and the wiring of the sensor of short circuit.</p> <p>The function is calculated by means of the actual value, the degree of operation and a λ[P028]H.Ct - Sampling Time of Heating (page 30) dependent time. This assures the detection of already existing as well as suddenly arising short circuits.</p> <p>A short circuit alarm of a sensor is displayed, if</p> <ul style="list-style-type: none"> ■ after a sampling time dependent time no temperature rising is detected although the controller outputs the maximum degree of operation. ■ a sudden drop of temperature is detected. <p>After detection of a short circuit of the sensor tCSC is shown in the actual value display and the zone is deactivated. The zone can be activated by the acknowledgement of the alarms (λInformation Level (page 20)).</p>
[oFF]	Function deactivated

[P023]tC.ti - Testing Period for Manual Short Circuit Supervision of Sensor

Value range: [0]...999 seconds

Is the temperature increase after the expiration of the testing period not 5K, although the controller outputs the maximum degree of operation, a short circuit alarm was detected.

The zone is deactivated (degree of operation 0%). In the actual value display tCSC is shown. The zone can be activated by the acknowledgement of the alarm.

[P024]APPL - Application

Without function.

6.2 Control parameter

This parameter group consists of the control parameters and the parameters that affect the automatic control parameter calculation.

[P025]H.Pb - Proportional Band of Heating

Value range: 0.0...25.5% [6.5]

[P026]H.td - Derivative Time of Heating

Value range: 0...2000 seconds [50]

[P027]H.ti - Integral Time of Heating

Value range: 0...2000 seconds [50]

[P028]H.Ct - Sampling Time of Heating

Value range: 0.2...90.0 seconds [0.2]

[P029]C.Pb - Proportional Band of Cooling

Value range: 0.0...25.5% [6.5]

[P030]C.td - Derivative Time of Cooling

Value range: 0...2000 seconds [50]

[P031]C.ti - Integral Time of Cooling

Value range: 0...2000 seconds [50]

[P032]C.Ct - Sampling Time of Cooling

Value range: 0.2...90.0 seconds [1.0]

[P033]IdE.H - Identification Heating

[on]	<p>The control parameters <i>Heating</i> are calculated after the first change of the set point greater than 50K after...</p> <ul style="list-style-type: none"> ■ a reset of a zone (λ[P006]ZonE - Status of Zone (page 28) = off) ■ or switch-on of controller ■ or after setpoint value 0°C/32K <p>are calculated during heating-up.</p> <p>During the identification phase Id and actual value are shown alternately in the display.</p>
oFF	<p>Function deactivated</p> <p>No parameter calculation for control parameters of heating is done during the heating up phase. The heating is done due to the adjusted set point.</p>

[P034]IdE.C - Identification Cooling after Identification Heating

on	<p>The function only operates on setting \nearrow[P048]Cool - Heating/Cooling (page 33)=on.</p> <p>The control parameters <i>Cooling</i> are automatically determined after completion of \nearrow[P033]IdE.H - Identification Heating (page 30).</p> <p>The control parameters of cooling are calculated according to the actual value pattern while the output is set to the least degree of operation. During identification phase Id- is shown in the display.</p> <p>After completion of the calculation of the control parameters the controller operates with the active set point again.</p>
[oFF]	After completion of the identification <i>Heating</i> no identification <i>Cooling</i> is executed.

[P035]IdE.L - Loop Control

on	During identification phase <i>Heating</i> the control response at reaching the set point is additionally considered and if necessary a correction of the control parameters of heating is performed.
[oFF]	Function deactivated

[P036] SP.Cb - Set Point Cutback

Value range: [0]...25.5 K

The function only operates on setting \nearrow [P035]IdE.L - Loop Control (page 31)=on.

The set point cutback function is embedded to prevent an overshoot in the identification phase. The calculation of the control parameters of heating is performed by a set point cutback reduced temperature set point. Thereafter the controller operates with the temperature set point.



In the following diagram a complete trend (actual / set point / value and degree of operation) of an automatic control parameter calculation

is described. The trend was recorded with the following parameter setting:

- \nearrow [P033]IdE.H - Identification Heating (page 30) = on
- \nearrow [P034]IdE.C - Identification Cooling after Identification Heating (page 31) = on
- \nearrow [P035]IdE.L - Loop Control (page 31) = on
- \nearrow [P036] SP.Cb - Set Point Cutback (page 31) = off
- \nearrow [P036] SP.Cb - Set Point Cutback (page 31) = 20

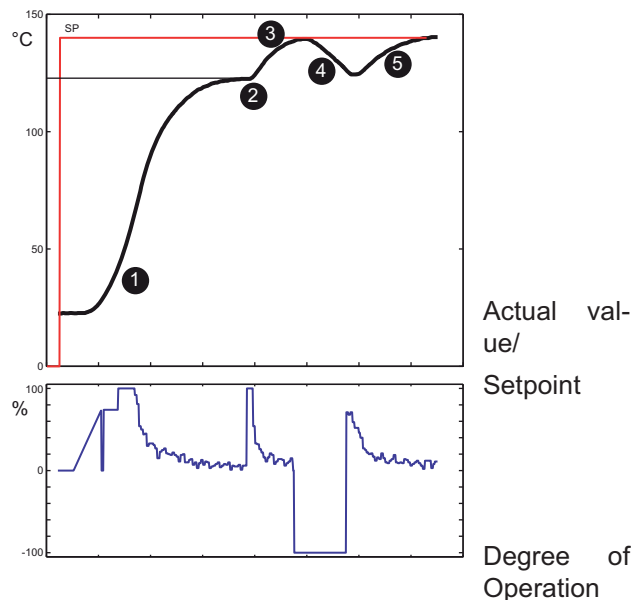

1 - After set point jump from 0°C to 140°C the control parameters of heating are calculated during heating up.

2 - 20°C (set point cutback) before reaching the set point of 140°C the calculation of the control parameters of heating is completed.

3 - The controller operates with the adjusted set point.

4 - After the actual value has reached the adjusted set point, the calculation of the control parameters of cooling is started.

5 - After the calculation of the control parameters of cooling is completed, the controller operates with the adjusted set point.

[P037]C.Con - Control Parameter Cooling constant after Identification Heating

In accordance with the dimensioning of the efficiency of heating and of cooling at zones the control parameters *Cooling* can generally be derived from the control parameters *Heating*.

on	The control parameters <i>Cooling</i> are not determined after identification <i>Heating</i> .
[oFF]	Is the function deactivated, the control parameters <i>Cooling</i> are derived from the control parameters <i>Heating</i> after identification <i>Heating</i> .

6.3 Group functions

To use the controller overall and operating functions the controller has to be allocated to a group.



Prerequisite for all group function is the networking of the controllers by CAN-Bus interface.

[P038]GP.rt - Remote Group

Value range: [0]...32

With the remote operation function the operation of multiple controllers is facilitated. For all controllers allocated to one remote operation group the operations on information level are synchronously processed. It is negligible on which controller of the remote operation group the operation is processed.

[P039]GP.nr - Group Number

Value range: [0]...32

For all controllers allocated to one remote operation group

- the automatic ramp
- the timers

are controller overall synchronized.

[P040]GP.Fu - Group Function

Value range: [0]...255

6.4 Definition of Temperature Limit Values

This parameter group determines how the temperature limit values adjusted by the main functions are evaluated.



A combination of several alarms can be used for one temperature limit value. In this case the sum of all identifiers has to be entered for the parameter.



5 (is equivalent to the sum of identifiers 1 and 4) is entered when an alarm should be generated on exceeding an absolute alarm limit value.



The default value 0 defines a relative alarm limit value.

[P041]Li.1d - Definition of Temperature Limit 1

Value range: [0]...255

Identification	Alarm mode
1	Absolute alarm limit value. Otherwise: Alarm limit value relative to set point.
2	Alarm is generated after reaching the alarm value first time. Otherwise: Alarm is always generated.

Identification	Alarm mode
4	Only valid for absolute alarm limit values. Alarm on actual value > limit value. Otherwise: Alarm on actual value < limit value.
8	Without function.
16	Only valid for C296: Supervise measuring input A.
32	Only valid for C296: Supervise measuring input B.
64	Only valid for C296: Supervise measuring input C.
128	Hysteresis Limit Value Li1/Li2 for [P041] and [P042] Hysteresis Limit Value Li3/Li4 for [P043] and [P044] ↪ Alarm Hysteresis Function

[P042]Li.2d - Definition of Temperature Limit 2

Value range: [0]...255

↪ [P041]Li.1d - Definition of Temperature Limit 1

[P043]Li.3d - Definition of Temperature Limit 3

Value range: [0]...255

↪ [P041]Li.1d - Definition of Temperature Limit 1

[P044]Li.4d - Definition of Temperature Limit 4

Value range: [0]...255

↪ [P041]Li.1d - Definition of Temperature Limit 1

6.5 Configuration of Base functions

[P045]Out.H - Maximum Degree of Operation Heating

Value range: 0...[100]%

Upper limitation of degree of operation in control mode.

[P046]Out.C - Maximum Degree of Operation of Cooling

Value range: [-100]...0 %

Lower limitation of degree of operation in control mode.

[P047]Out.m - Maximum Degree of Operation in Manual Mode

Value range: -100...[100]%

Upper limitation of degree of operation in ↗[P002]mAnU - Manual Mode (page 28).

Function also active with ↗[P022]tC.AL - Autom. Short Circuit Supervision of Sensor (page 30).

[P048]Cool - Heating/Cooling

on	Controller operates as three-position controller (Heating/Cooling).
----	---

[oFF]	Controller operates as two-position controller (Heating).
-------	---

[P049]rEL.H - Relay Output Heating

	If degree of operation > 0...
on	<ul style="list-style-type: none"> ■ ... only one on/off switching operation at control output during one sampling cycle. ■ ... sampling time is set to minimum 10 seconds.
[oFF]	... output of degree of operation with quickly clocked, short pulses (e.g. output for Solid State Relays).

[P050]rEL.C - Relay Output Cooling

	If degree of operation < 0...
[on]	<ul style="list-style-type: none"> ■ ... only one on/off switching operation at control output during one sampling cycle. ■ ... sampling time is set to minimum 10 seconds.
oFF	... output of degree of operation with quickly clocked, short pulses (e.g. output for Solid State Relays).

[P051]SP.Lo - Lower Set Point Limit

Value range: [0.0]...1500.0 °C

Minimum adjustable set point.

[P052]SP.Hi - Upper Set Point Limit

Value range: 0.0...1500.0 °C [500.0]

Maximum adjustable set point.

[P053]Cur.d - Current Supervision Function

Value range: 0...99

Prerequisite: current transformer connected.

0	Deactivated current monitoring
[1]	Measuring cycle 30 seconds. Analysis of currents > 0.3 A
2	Measuring cycle 30 seconds. Analysis of currents > 0.2 A
3	Measuring only for degree of operation > 0% Measuring cycle 30 seconds. Analysis of currents > 0.3 A
4	Measuring only for degree of operation > 0% Measuring cycle 30 seconds. Analysis of currents > 0.2 A
8	Master in Master-/Slave current measuring. Measuring cycle 30 seconds.
9	Slave in Master-/Slave current measuring. Measuring cycle 30 seconds.
11-19	Like 1 ... 9, only with measuring cycle 15 seconds.
21-29	Like 1 ... 9 only with measuring cycle 10 seconds.

[P054]Cur.E - Final Value of Measurement Range of Current Supervision

Value range: 0...999.9% [100.0]

Scaling of the current measuring input when the output signal of the current transformer is different from 42mV/A or the feed line of the heating element is repeatedly led through the current transformer.

[P055]CELS - Temperature Unit

C	Celsius
F	Degrees Fahrenheit. LED °F on the front of the controller is illuminated.

6.6 Display

The displays are adjusted by means of this parameter group.

[P056]deCP - Display of Format of Temperature Values

Value range: 0.1/[1.0]

Display / data entry of all temperature values by LED display with or without decimal place. Entry by serial data interface RS485 and CAN-Bus interface always in format 0.1.

[P057]dmAn - Display in Manual Mode

[out]	Display of degree of operation
tEmP	Display of actual value

6.7 Configuration of Hardware

The mode of operation of in- and outputs at the controller is adjusted by means of this parameter group. The setting in general has to be done once at start-up.

[P058]dO.1 - Mode of Operation of Digital Output 1

oFF	Output without function
[HEAt]	Output of control signal <i>Heating</i>
Cool	Output of control signal <i>Cooling</i>
AL1	Output switched, if at least one alarm defined by ↗[P082]A1.d1 - Alarm Flag 1, Definition 1 (page 37) or ↗[P083]A1.d2 - Alarm Flag 1, Definition 2 (page 38) is active.
AL2	Output switched, if at least one alarm defined by ↗[P084]A2.d1 - Alarm Flag 2, Definition 1 (page 38) or ↗[P085]A2.d2 - Alarm Flag 2, Definition 2 (page 38) is active.
AL3	Output switched, if at least one alarm defined by ↗[P086]A3.d1 - Alarm Flag 3, Definition 1 (page 38) or ↗[P087]A3.d2 - Alarm Flag 3, Definition 2 (page 38) is active.

AL4	Output switched, if at least one alarm defined by ↗[P088]A4.d1 - Alarm Flag 4, Definition 1 (page 38) or ↗[P089]A4.d2 - Alarm Flag 4, Definition 2 (page 38) is active.
AL1-	Like ↗AL1 (page 33). Output inverted.
AL2-	Like ↗AL2 (page 33). Output inverted.
AL3-	Like ↗AL3 (page 34). Output inverted.
AL4-	Like ↗AL4 (page 34). Output inverted.
t1	Output switched, if timer 1 active
t2	Output switched, if timer 2 active
t3	Output switched, if timer 3 active
t4	Output switched, if timer 4 active
t1-	Output switched, if timer 1 is not active
t2-	Output switched, if timer 2 is not active
t3-	Output switched, if timer 3 is not active
t4-	Output switched, if timer 4 is not active
Co.OP	Open valve For valve control. Only degree of operation changes are output. Not at [P066], [P067]
Co.CL	Close valve For valve control. Only degree of operation changes are output. Not at [P066], [P067]

[P059]dO.2 - Mode of Operation of Digital Output 2

↗[P058]dO.1 - Mode of Operation of Digital Output 1

Default value [Cool]

[P060]dO.3 - Mode of Operation of Digital Output 3

↗[P058]dO.1 - Mode of Operation of Digital Output 1

Default value [AL1]

[P061]dO.4 - Mode of Operation of Digital Output 4

↗[P058]dO.1 - Mode of Operation of Digital Output 1 (page 33)

Default value [AL2]

[P062]dIn.1 - Mode of Operation of Digital Input 1

	Is digital input 1 active...
[oFF]	Digital input without function
P.on	... it is indicated to the controller that the power controller for heating is connected. Is digital input 1 inactive the control is stopped, no control signal and no current tolerance alarms are generated.
P.oFF	... it is indicated to the controller that the power controller for heating is disconnected.
SP2.A	... the controller operates with the 2nd set point.

	Is digital input 1 active...
SP3.A	... the controller operates with the 3rd set point.
SP4.A	... the controller operates with the 4th set point.
SP2.r	... the set point is increased or decreased by the 2nd set point.
SP3.r	... the set point is increased or decreased by the 3rd set point.
SP4.r	... the set point is increased or decreased by the 4th set point.
H.oFF	... the heating output is permanently switched off.
H.on	... the heating output is permanently switched on.
C.oFF	... the cooling output is permanently switched off.
C.on	... the cooling output is permanently switched on.
SP.bA	
SP.br	
AL.CL	... the activated and stored alarm outputs are reset.
t1	... timer 1 started by switch on edge.
t2	... timer 2 started by switch on edge.
t3	... timer 3 started by switch on edge.
t4	... timer 4 started by switch on edge.
t1-	... timer 1 started by switch off edge.
t2-	... timer 2 started by switch off edge.
t3-	... timer 3 started by switch off edge.
t4-	... timer 4 started by switch off edge.
iLoC	... entry by membrane keypad is locked. No entry by membrane keypad is feasible.

[P063]dIn.2 - Mode of Operation of Digital Input 2

↗[P062]dIn.1 - Mode of Operation of Digital Input 1

[P064]OPt.A - Definition of Option A

Setting of function of option A.

The factory-made default setting depends on the device specification. For controllers without options the default setting is in each case oFF.

[oFF]	Option A not available
rS	Interface RS485
dI	Digital input
dO	Digital output
AO	Analog output 0...10VDC/0...20mA
AO.O	Analog output 2...10VDC/4...20mA

[P065]OPt.b - Definition of Option B

Setting of function of option B.

The factory-made default setting depends on the device specification.

[oFF]	Option B not available
CAn	CAN-Bus
dI	Digital input
dO	Digital output
AO	Analog output 0...10VDC/0...20mA
AO.O	Analog output 2...10VDC/4...20mA

[P066]dO.A - Mode of Operation of Digital Output Option A

Prerequisite: Option A is configured as digital output.

→ [P058]dO.1 - Mode of Operation of Digital Output 1

[P067]dO.b - Mode of Operation of Digital Output Option B

Prerequisite: Option B is configured as digital output.

→ [P058]dO.1 - Mode of Operation of Digital Output 1

[P068]dIn.A - Mode of Operation of Digital Input Option A

Prerequisite: Option A is configured as digital input (↗dI (page 34)).

→ [P062]dIn.1 - Mode of Operation of Digital Input 1

[P069]dIn.b - Mode of Operation of Digital Input Option B

Prerequisite: Option B is configured as digital input (↗dI (page 34)).

→ [P062]dIn.1 - Mode of Operation of Digital Input 1

[P070]AO.A - Mode of Operation of Analog Output Option A

Prerequisite: Option A is configured as analog output (↗AO (page 35) or ↗AO.O (page 35)).

[oFF]	Output without function
out.H	Output of degree of operation of heating.
out.C	Output of degree of operation of cooling.
SEn.C	Output of value defined by ↗[P073]SEn.C - Measuring Input for Control (page 35).
S.C b	Output of value defined by ↗[P073]SEn.C - Measuring Input for Control (page 35), scaled by parameter Aib.L and Aib.H.
S.C C	Output of value defined by ↗[P073]SEn.C - Measuring Input for Control (page 35), scaled by parameter AiC.L and AiC.H.
IntF	Output of specified value by serial interface or CAN-Bus.

[P071]AO.b - Mode of Operation of Analog Output Option B

Prerequisite: Option B is configured as analog output (↗AO (page 35) or ↗AO.O (page 35)).

→ [P070]AO.A - Mode of Operation of Analog Output Option A

[P072]SEn - Sensor Type of Measuring Input A

L	Fe-CuNi Type L
[J]	Fe-CuNi Type J
niCr	Ni-CrNi Type K
Pt	Resistance thermometer Pt100

[P073]SEn.C - Measuring Input for Control



Parameter is only valid for C296.

Presetting which of the three actual values or a combination of these are used for control.

[A]	Input A
b	Input B
C	Input C
A-b	Difference (measuring input A - measuring input B)
b-A	Difference (measuring input B - measuring input A)
A-C	Difference (measuring input A - measuring input C)
C-A	Difference (measuring input C - measuring input A)
C-b	Difference (measuring input C - measuring input B)
b-C	Difference (measuring input B - measuring input C)

For measuring input B and C the limit ranges configured by Aib.L, Aib.H, AiC.L and AiC.H are valid.

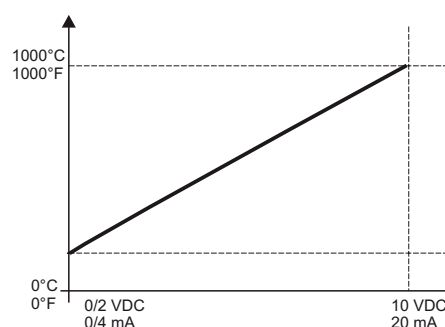

[P074]Sen.S - Measuring Input for Presetting of Set Point



Parameter is only valid for C296.

[oFF]	Presetting of set point by keypad, serial interface or CAN-Bus.
A	Presetting of set point by measuring input A.
b	Presetting of set point by measuring input B.
C	Presetting of set point by measuring input C.

Exceeds the input value the measurement range, the current set point of control is set to \nearrow [P001]SP - Set Point (page 28), otherwise the input value is taken for current set point of control. The function "set point value change" is executed for a set point change > 0.5 °C.

For measuring input B and C the input ranges configured by Aib.L, Aib.H, AiC.L und AiC.H are valid.

[P075]oFF.A - Offset of Measuring Input A

Value range: -100.0...100.0 [0.0]

Correction of the actual value display of measuring input A dependent on temperature unit. E.g. for compensation of the measurement error caused by the output resistance of a resistance thermometer Pt100.

Actual value display = measured value + 'Offset of Measuring Input A'

[P076]oFF.b - Measurement range of Measuring Input B

[0-10]	Measurement range 0...10 VDC
2-10	Measurement range 2...10 VDC

[P077]oFF.C - Measurement range of Measuring Input C

0-20	Measurement range 0...20 mA
[4-20]	Measurement range 4...20 mA

[P078]Aib.L - Lower Display Limit of Measuring Input B

Value range: -100.0...1500.0 [0.0]

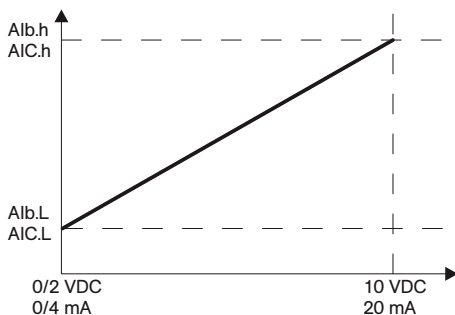

Defines the display value of measuring input B for a measured value of 0 respectively 2 VDC or 0 respectively 4mA.

The characteristic of the display values for measuring input B is defined by \nearrow [P079]Aib.H - Upper Display Limit of Measuring Input B (page 37).

The set point of control is linear output between AI*.L and AI*.H. For the set point of control beneath AI*.L, 0 is output; above AI*.H, maximal value is output.

[P079]Aib.H - Upper Display Limit of Measuring Input B

Value range: -100.0...1500.0 [999.9]

\rightarrow [P078]Aib.L - Lower Display Limit of Measuring Input B

[P080]AiC.L - Lower Display Limit of Measuring Input C

Value range: -100.0...1500.0 [0.0]

\rightarrow [P078]Aib.L - Lower Display Limit of Measuring Input B

[P081]AiC.H - Upper Display Limit of Measuring Input C

Value range: -100.0...1500.0 [999.9]

\rightarrow [P078]Aib.L - Lower Display Limit of Measuring Input B

6.8 Configuration of Alarm Flags

The controller offers a total of four alarm flags.

The status of the alarm flags is defined by two parameters (definition groups). Is at least one defined process alarm active, the status of the alarm flag equals 1. The status of the alarm flags can be shown on the digital outputs.

The function of the alarm flag is defined by the alarm identifiers set (0 = nothing set).

[P082]A1.d1 - Alarm Flag 1, Definition 1

Value range: 0...255 [4]

Identification	Alarm
1	Current alarm on heating off - current is measured for degree of operation 0%
2	Current tolerance alarm
4	\nearrow [P007]Li.1 - Temperature Limit 1 (page 28)
8	\nearrow [P008]Li.2 - Temperature Limit 2 (page 28)
16	\nearrow [P009]Li.3 - Temperature Limit 3 (page 28)
32	\nearrow [P010]Li.4 - Temperature Limit 4 (page 28)
64	Sensor short-circuit
128	Sensor break/sensor incorrect polarity

[P083]A1.d2 - Alarm Flag 1, Definition 2

Default value [0]

Identification	Alarm
1	Error during identification phase / drift
2	Actual value greater than end of measurement range
4	Hysteresis Limit Value Li3/Li4 → Alarm Hysteresis Function
8	Hysteresis Limit Value Li1/Li2 → Alarm Hysteresis Function
16	Without function
32	Without function
64	Alarm flag can be acknowledged
128	Alarm flag storing

[P084]A2.d1 - Alarm Flag 2, Definition 1

Value range: 0...255 [8]

→ [P082]A1.d1 - Alarm Flag 1, Definition 1

[P085]A2.d2 - Alarm Flag 2, Definition 2

Value range: 0...255 [0]

→ [P083]A1.d2 - Alarm Flag 1, Definition 2

[P086]A3.d1 - Alarm Flag 3, Definition 1

Value range: 0...255 [2]

→ [P082]A1.d1 - Alarm Flag 1, Definition 1

[P087]A3.d2 - Alarm Flag 3, Definition 2

Value range: 0...255 [0]

→ [P083]A1.d2 - Alarm Flag 1, Definition 2



By setting of A3.d* the status of the alarm flag is output on the digital outputs and on the LED B and/or E (output cooling / alarm output 3).

[P088]A4.d1 - Alarm Flag 4, Definition 1

Value range: 0...255 [1]

→ [P082]A1.d1 - Alarm Flag 1, Definition 1

[P089]A4.d2 - Alarm Flag 4, Definition 2

→ [P083]A1.d2 - Alarm Flag 1, Definition 2

Value range: 0...255 [0]

6.9 Definition of Timers

The controller offers a total of four timers where complex sequences of functions can be realized.

The function and how the timer acts are defined by two parameters.

[P090]t1.d1 - Mode of Operation of Timer 1, Definition 1

With the first parameter of a timer is defined which function is performed when the timer is active.

[oFF]	No function.
-------	--------------

P.on	The power controller of heating is switched on.
P.oFF	The power controller of heating is switched off.
SP2.A	The controller operates with the 2nd set point.
SP3.A	The controller operates with the 3rd set point.
SP4.A	The controller operates with the 4th set point.
SP2.r	The set point is increased or decreased by the 2nd set point.
SP3.r	The set point is increased or decreased by the 3rd set point.
SP4.r	The set point is increased or decreased by the 4th set point.
H.oFF	Heating output is switched off.
H.on	Heating output is switched on.
C.oFF	Cooling output is switched off.
C.on	Cooling output is switched on.
SP.bA	
SP.br	
AL.CL	Stored alarms outputs are reset.

[P091]t1.d2 - Mode of Operation of Timer 1, Definition 2

With the second parameter of a timer is defined how the timer is started and which action is performed after termination of the timer.

*) For parameter t.rES = Auto, a Soft-Reset has the same effect like controller start.

[oFF]	Timer is not started.
Auto	Timer is automatically started after controller start *).
A.t1	Timer is automatically started after controller start *). After termination: Start of timer 1.
A.t2	Timer is automatically started after controller start *). After termination: Start of timer 2.
A.t3	Timer is automatically started after controller start *). After termination: Start of timer 3.
A.t4	Timer is automatically started after controller start *). After termination: Start of timer 4.
t1	After termination: Start of timer 1.
t2	After termination: Start of timer 2.
t3	After termination: Start of timer 3.
t4	After termination: Start of timer 4.

AL.t1	Timer is started when the actual value reaches the 5K band around the set point directly after start of the controller. After termination: Start of timer 1.
AL.t2	Timer is started when the actual value reaches the 5K band around the set point directly after start of the controller. After termination: Start of timer 2.
AL.t3	Timer is started when the actual value reaches the 5K band around the set point directly after start of the controller. After termination: Start of timer 3.
AL.t4	Timer is started when the actual value reaches the 5K band around the set point directly after start of the controller. After termination: Start of timer 4.
L.t1	Timer is started when the actual value reaches the 5K band around the set point. After termination: Start of timer 1.
L.t2	Timer is started when the actual value reaches the 5K band around the set point. After termination: Start of timer 2.
L.t3	Timer is started when the actual value reaches the 5K band around the set point. After termination: Start of timer 3.
L.t4	Timer is started when the actual value reaches the 5K band around the set point. After termination: Start of timer 4.
AL	Timer is started when the actual value reaches the 5K band around the set point directly after start of the controller.
L	Timer is started when the actual value reaches the 5K band around the set point.
AS	Timer is started when set point > 100 °C and actual value < 90 °C.
AS.t1	Timer is started when set point > 100 °C and actual value < 90 °C. After termination: Start of timer 1.
AS.t2	Timer is started when set point > 100 °C and actual value < 90 °C. After termination: Start of timer 2.
AS.t3	Timer is started when set point > 100 °C and actual value < 90 °C. After termination: Start of timer 3.
AS.t4	Timer is started when set point > 100 °C and actual value < 90 °C. After termination: Start of timer 4.

[P092]t2.d1 - Mode of Operation of Timer 2, Definition 1

↳[P090]t1.d1 - Mode of Operation of Timer 1, Definition 1

[P093]t2.d2 - Mode of Operation of Timer 2, Definition 2

↳[P091]t1.d2 - Mode of Operation of Timer 1, Definition 2

[P094]t3.d1 - Mode of Operation of Timer 3, Definition 1

↳[P090]t1.d1 - Mode of Operation of Timer 1, Definition 1

[P095]t3.d2 - Mode of Operation of Timer 3, Definition 2

↳[P091]t1.d2 - Mode of Operation of Timer 1, Definition 2

[P096]t4.d1 - Mode of Operation of Timer 4, Definition 1

↳[P090]t1.d1 - Mode of Operation of Timer 1, Definition 1

[P097]t4.d2 - Mode of Operation of Timer 4, Definition 2

↳[P091]t1.d2 - Mode of Operation of Timer 1, Definition 2

[P098]t.rES - Mode of Operation of Timer after Soft-Reset

A soft reset stands for a sensor break, a reset of a set point to zero or a passivation of a zone.

[run]	Timer keeps on running.
StoP	Timer is stopped and reset.
Auto	Timer is stopped, reset and after soft reset started again in case of t*.d2 = Auto and/or A.**.

6.10 Configuration of Operation

[P099]Edit - Entry Mode Directly

[on]	After selection the parameters in operator and system level can <i>directly</i> be changed by keypad. In this mode the direct data entry for degree of operation/ set point value by decrease/increase button is feasible.
oFF	After selection the parameters in operator and system level can only be changed after unblocking by keypad by decrease/increase button.

[P100]iLoc - Entry Lock on Info Level

on	No data entry on information level feasible.
[oFF]	Data entry on information level feasible.

[P110]ULoc - Entry Lock on User/System level

After restart of the device, all data entry except setpoint value and degree of operation is automatically blocked.

The unlocking of user level USEr is done by entering the value set here as code number (see chapter ↗Enter Code Number (page 24)). The unlocking of system level SYS is done by entering the value set here +10 as code number.

[0]	No entry on user/system level possible.
1-100	Entry on user/system level possible. Input blocking is automatically reactivated 1 minute after the last key operation.

6.11 Configuration of Data Interface

The two optional available data interfaces are configured by means of this parameter group.

[P101]S.Adr - Address of serial interface

Address of device for communication via the serial data interface with ↗PSGII-Protocol (page 40).

[P102]S.Pro - Protocol of Serial Interface

[PSG]	PSGII-Protocol
rtU	Modbus RTU

Interface specifications are available on request.

[P103]S.bd - Baud Rate of Serial Interface

Value range: 1200, 2400, 4800, 9600, [19.2], 38.4

Transfer rate of serial interface.

[P104]S.Sto - Stop Bits of Serial Interface

Value range: [1]/2

Number of stop bits of serial data interface.

[P105]S.PAr - Parity of Serial Interface

Parity bit, for the detection of transfer errors.

[no]	No parity bit.
EvEn	The parity bit complements the 1 bits in the bit string to a even number of 1 bits.
odd	The parity bit complements the 1 bits in the bit string to a odd number of 1 bits.

[P106]C.bAS - CAN base address

Value range: 0...127 [32]

Resulting Node id of the controller: C.bAS + S.Adr

[P107]C.bd - CAN baud rate

Value range: 78.8, 100, 125, [250], 500, 800, 1000

Transfer rate of CAN-Bus.

[P108]C.OP - CAN Auto Operational Mode

In case of networking of several controllers by CAN-Bus without CAN-Bus-Master at least one controller has to send out the auto operational command.

oFF	Controller sends <i>no</i> auto operational command.
-----	--

[Auto]	Controller sends auto operational command cyclical.
--------	---

[P109]m.Adr - MODBUS address

Value range: 0...255 [1]

6.12 Basic settings for Special Applications

The temperature controllers can easily be adapted to any application. For some applications the parameter modifications based on the factory-made delivery status are shown exemplarily. To change all parameters select ↗System Level (page 22).

6.12.1 Application Hot Runner Control

Start-up Function

After start the controller operates for a definite time with the set point for start-up. ↗[P013]SP.4 - Set Point 4 (page 29) is used for this function.

- Define mode of operation for the start-up timer after start of the controller:
↗[P090]t1.d1 - Mode of Operation of Timer 1, Definition 1 (page 38) = SP4.A and ↗[P091]t1.d2 - Mode of Operation of Timer 1, Definition 2 (page 38) = AL.t2
- Define period of start-up mode:
↗[P017]t1 - Process Timer 1 (page 29) = 600 (seconds)
- Define temperature value on which the controller operates in start-up mode:
↗[P013]SP.4 - Set Point 4 (page 29) = 100

Boost Function

In the boost mode the temperature set point is increased by an adjustable temperature value, e.g. to heat up the hot runner nozzles before start of the production. The boost mode is automatically started after start-up function or by a signal on the digital input 2 (only C296) of the controller. For boost mode ↗[P012]SP.3 - Set Point 3 (page 28) is used.

- Define mode of operation for the second digital input:
↗[P063]dIn.2 - Mode of Operation of Digital Input 2 (page 34) = t2 (only C296)
- Define a temperature value that increases („boosts“) the temperature:
↗[P012]SP.3 - Set Point 3 (page 28)
- Define mode of operation for the boost timer:
↗[P092]t2.d1 - Mode of Operation of Timer 2, Definition 1 (page 39) = SP3.r and ↗[P093]t2.d2 - Mode of Operation of Timer 2, Definition 2 (page 39) = L
- Define period of boost mode:
↗[P018]t2 - Process Timer 2 (page 29) = 300 (seconds)

Stand-by Function

If the digital input 1 is active, the controller operates with the reduced set point.

- Define mode of operation of digital input 1:
 \nearrow [P062]dIn.1 - Mode of Operation of Digital Input 1 (page 34) = SP2.r
- Define temperature value for lowering by:
 \nearrow [P011]SP.2 - Set Point 2 (page 28) = 100.0

Alarm monitoring

An alarm is generated when the temperature value exceeds the defined band around the temperature set point.

- Define upper temperature limit:
 \nearrow [P007]Li.1 - Temperature Limit 1 (page 28) = 5°C
- Define lower temperature limit:
 \nearrow [P008]Li.2 - Temperature Limit 2 (page 28) = -5°C
- Define identifiers of alarm flag:
 \nearrow [P082]A1.d1 - Alarm Flag 1, Definition 1 (page 37) = 12
- Alarm flag should be generated on digital output:
 \nearrow [P059]dO.2 - Mode of Operation of Digital Output 2 (page 34) = AL1

6.12.2 Application Extrusion

Three-point zone (Heating/Cooling)

- Activate cooling: \nearrow [P048]Cool - Heating/Cooling (page 33) = on
- Activate auto tuning for cooling: \nearrow [P034]IdE.C - Identification Cooling after Identification Heating (page 31) = on

Besides the controller is preset for the operation with an extruder.

6.12.3 Application Hot Air

To achieve optimal control results, the automatic calculation of the heating control parameters should be deactivated and the heating control parameters should be manually entered.

- Deactivate automatic calculation of heating control parameters:
 \nearrow [P033]IdE.H - Identification Heating (page 30) = off
- Set heating control parameters:
 \nearrow [P025]H.Pb - Proportional Band of Heating (page 30) = 15
 \nearrow [P026]H.td - Derivative Time of Heating (page 30) = 1
 \nearrow [P027]H.ti - Integral Time of Heating (page 30) = 3
 \nearrow [P028]H.Ct - Sampling Time of Heating (page 30) = 0.3

In case these control parameters are not leading to an optimal result for your hot air zones, please contact Hotset GmbH.

For a further adaptation of the heating control parameters please watch the actual value as well as the dedicated degree of operation.

6.12.4 Alarm Hysteresis Function

To generate an alarm dependent on the exceeding of an absolute upper limit value, that is pending, as long

as an absolute lower limit value is not under-run, the alarm hysteresis function can be used.

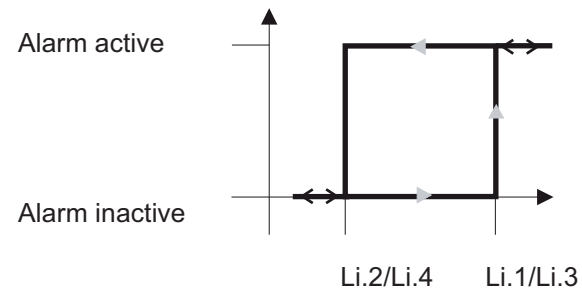

The function

- generates an alarm, even though \nearrow [P001]SP - Set Point (page 28) = 0
- generates no alarm, when \nearrow [P006]ZonE - Status of Zone (page 28) = oFF

To output the alarm on a digital output, it must be assigned to an alarm flag. The following setting must be done for the alarm hysteresis function.

- \nearrow [P007]Li.1 - Temperature Limit 1 (page 28): set upper limit value
- \nearrow [P008]Li.2 - Temperature Limit 2 (page 28): set lower limit value
- set \nearrow [P041]Li.1d - Definition of Temperature Limit 1 (page 32) = 128
- set \nearrow [P042]Li.2d - Definition of Temperature Limit 2 (page 32) = 128
- Alarm flag 1 should be used for example. Set \nearrow [P083]A1.d2 - Alarm Flag 1, Definition 2 (page 38) = 8.
- The alarm flag should be output on digital output 1 for example. Set \nearrow [P058]dO.1 - Mode of Operation of Digital Output 1 (page 33) = AL1.

Instead of the parameters [P007], [P008] and [P041], [P042] also the parameters [P009], [P010] and [P043], [P044] could be used. The used alarm flag (example see above) \nearrow [P083]A1.d2 - Alarm Flag 1, Definition 2 (page 38) must be set to 4.

7 Appendix

7.1 Parameters/factory delivery status

Designation/characteristic analog mnemonic/parameter	Value range (physical value)	Standard	My Settings	Enabling	My enabling
↗[P001]SP - Set Point	0...1500.0	0		Edit	
↗[P002]mAnU - Manual Mode	oFF, on	oFF		Edit	
↗[P003]Out - Degree of Operation	-100...100	0		Edit	
↗[P004]Cur.S - Set Point of Heater Current	0.0...999.0	0.0		Edit	
↗[P005]Cur.t - Tolerance Band of Heater Current	0...100	20		Edit	
↗[P006]ZonE - Status of Zone	oFF, on	on		Edit	
↗[P007]Li.1 - Temperature Limit 1	-999.0...1500.0	5		Edit	
↗[P008]Li.2 - Temperature Limit 2	-999.0...1500.0	-5		Edit	
↗[P009]Li.3 - Temperature Limit 3	-999.0...1500.0	0		Edit	
↗[P010]Li.4 - Temperature Limit 4	-999.0...1500.0	0		Edit	
↗[P011]SP.2 - Set Point 2	-999.0...1500.0	0		Edit	
↗[P012]SP.3 - Set Point 3	-999.0...1500.0	0		Edit	
↗[P013]SP.4 - Set Point 4	-999.0...1500.0	0		Edit	
↗[P014]rAP.t - Temperature Ramp	-999.0...999.0	0		Edit	
↗[P015]rAP.A - Automatic Temperature Ramp	oFF, on	oFF		Edit	
↗[P016]rAP.G - Temperature Band of Autom. Temperature Ramp	2.0...25.5	5.0		Edit	
↗[P017]t1 - Process Timer 1	0...9999	0		Edit	
↗[P018]t2 - Process Timer 2	0...9999	0		Edit	
↗[P019]t3 - Process Timer 3	0...9999	0		Edit	
↗[P020]t4 - Process Timer 4	0...9999	0		Edit	
↗[P021]AmAn - Automatic Manual Mode	oFF, on	oFF		hidE	
↗[P022]tC.AL - Autom. Short Circuit Supervision of Sensor	oFF, on	oFF		hidE	
↗[P023]tC.ti - Testing Period for Manual Short Circuit Supervision of Sensor	0...999	0		hidE	
↗[P024]APPL - Application	0...255	0		hidE	
↗[P025]H.Pb - Proportional Band of Heating	0.0...25.5	6.5		Edit	
↗[P026]H.td - Derivative Time of Heating	0...2000	50		Edit	
↗[P027]H.ti - Integral Time of Heating	0...2000	50		Edit	
↗[P028]H.Ct - Sampling Time of Heating	0.2...90.0	0.2		Edit	
↗[P029]C.Pb - Proportional Band of Cooling	0.0...25.5	6.5		Edit	
↗[P030]C.td - Derivative Time of Cooling	0...2000	50		Edit	
↗[P031]C.ti - Integral Time of Cooling	0...2000	50		Edit	
↗[P032]C.Ct - Sampling Time of Cooling	0.2...90.0	1.0		Edit	
↗[P033]IdE.H - Identification Heating	oFF, on	on		Edit	
↗[P034]IdE.C - Identification Cooling after Identification Heating	oFF, on	oFF		Edit	
↗[P035]IdE.L - Loop Control	oFF, on	oFF		Edit	
↗[P036]SP.Cb - Set Point Cutback	0.0...25.5	0.0		Edit	
↗[P037]C.Con - Control Parameter Cooling constant after Identification Heating	oFF, on	oFF		Edit	
↗[P038]GP.rt - Remote Group	0...32	0		hidE	
↗[P039]GP.nr - Group Number	0...32	0		hidE	
↗[P040]GP.Fu - Group Function	0...255	0		hidE	
↗[P041]Li.1d - Definition of Temperature Limit 1	0...255	0		Edit	
↗[P042]Li.2d - Definition of Temperature Limit 2	0...255	0		Edit	
↗[P043]Li.3d - Definition of Temperature Limit 3	0...255	0		Edit	
↗[P044]Li.4d - Definition of Temperature Limit 4	0...255	0		Edit	
↗[P045]Out.H - Maximum Degree of Operation Heating	0...100	100		hidE	
↗[P046]Out.C - Maximum Degree of Operation of Cooling	-100...0	-100		hidE	
↗[P047]Out.m - Maximum Degree of Operation in Manual Mode	-100...100	100		hidE	
↗[P048]Cool - Heating/Cooling	oFF, on	oFF		Edit	
↗[P049]rEL.H - Relay Output Heating	oFF, on	oFF		hidE	
↗[P050]rEL.C - Relay Output Cooling	oFF, on	on		hidE	
↗[P051]SP.Lo - Lower Set Point Limit	0.0...1500.0	0.0		hidE	
↗[P052]SP.Hi - Upper Set Point Limit	0.0...1500.0	500.0		hidE	
↗[P053]Cur.d - Current Supervision Function	0...99	1		hidE	
↗[P054]Cur.E - Final Value of Measurement Range of Current Supervision	0.0...999.0	100.0		hidE	
↗[P055]CELS - Temperature Unit	F, C	C		hidE	

Designation/characteristic analog mnemonic/parameter	Value range (physical value)	Standard	My Settings	Enabling	My enabling
↵[P056]deCP - Display of Format of Temperature Values	1.0, 0.1	0		hidE	
↵[P057]dmAn - Display in Manual Mode	tEmP, out	out		hidE	
↵[P058]dO.1 - Mode of Operation of Digital Output 1	oFF, HEAt, Cool, AL1, AL2, AL3, AL4, AL1-, AL2-, AL3-, AL4-, t1, t2, t3, t4, t1-, t2-, t3-, t4-, Co.OP, Co.CL	HEAt		hidE	
↵[P059]dO.2 - Mode of Operation of Digital Output 2	oFF, HEAt, Cool, AL1, AL2, AL3, AL4, AL1-, AL2-, AL3-, AL4-, t1, t2, t3, t4, t1-, t2-, t3-, t4-, Co.OP, Co.CL	Cool		hidE	
↵[P060]dO.3 - Mode of Operation of Digital Output 3	oFF, HEAt, Cool, AL1, AL2, AL3, AL4, AL1-, AL2-, AL3-, AL4-, t1, t2, t3, t4, t1-, t2-, t3-, t4-, Co.OP, Co.CL	AL1		hidE	
↵[P061]dO.4 - Mode of Operation of Digital Output 4	oFF, HEAt, Cool, AL1, AL2, AL3, AL4, AL1-, AL2-, AL3-, AL4-, t1, t2, t3, t4, t1-, t2-, t3-, t4-, Co.OP, Co.CL	AL2		hidE	
↵[P062]dIn.1 - Mode of Operation of Digital Input 1	oFF, P.on, P.oFF, SP2.A, SP3.A, SP4.A, SP2.r, SP3.r, SP4.r, H.oFF, H.on,C.oFF, C.on, SP.bA, SP.br, AL.CL, t1, t2, t3, t4, t1-, t2-, t3-, t4-, iLoc	oFF		hidE	
↵[P063]dIn.2 - Mode of Operation of Digital Input 2	oFF, P.on, P.oFF, SP2.A, SP3.A, SP4.A, SP2.r, SP3.r, SP4.r, H.oFF, H.on,C.oFF, C.on, SP.bA, SP.br, AL.CL, t1, t2, t3, t4, t1-, t2-, t3-, t4-, iLoc	oFF		hidE	
↵[P064]OPt.A - Definition of Option A	oFF, Sio, dl, dO, AO, AO.O	oFF		hidE	
↵[P065]OPt.b - Definition of Option B	oFF, CAn, dl, dO, AO, AO.O	oFF		hidE	
↵[P066]dO.A - Mode of Operation of Digital Output Option A	oFF, HEAt, Cool, AL1, AL2, AL3, AL4, AL1-, AL2-, AL3-, AL4-, t1, t2, t3, t4, t1-, t2-, t3-, t4-	oFF		hidE	
↵[P067]dO.b - Mode of Operation of Digital Output Option B	oFF, HEAt, Cool, AL1, AL2, AL3, AL4, AL1-, AL2-, AL3-, AL4-, t1, t2, t3, t4, t1-, t2-, t3-, t4-	oFF		hidE	
↵[P068]dIn.A - Mode of Operation of Digital Input Option A	oFF, P.on, P.oFF, SP2.A, SP3.A, SP4.A, SP2.r, SP3.r, SP4.r, H.oFF, H.on,C.oFF, C.on, SP.bA, SP.br, AL.CL, t1, t2, t3, t4, t1-, t2-, t3-, t4-, iLoc	oFF		hidE	
↵[P069]dIn.b - Mode of Operation of Digital Input Option B	oFF, P.on, P.oFF, SP2.A, SP3.A, SP4.A, SP2.r, SP3.r, SP4.r, H.oFF, H.on,C.oFF, C.on, SP.bA, SP.br, AL.CL, t1, t2, t3, t4, t1-, t2-, t3-, t4-, iLoc	oFF		hidE	
↵[P070]AO.A - Mode of Operation of Analog Output Option A	oFF, out.H, out.C, SEn.C, IntF, S.C b, S.C C	oFF		hidE	
↵[P071]AO.b - Mode of Operation of Analog Output Option B	oFF, out.H, out.C, SEn.C, IntF, S.C b, S.C C	oFF		hidE	
↵[P072]SEn - Sensor Type of Measuring Input A	L, J, niCr, Pt	J		Edit	
↵[P073]SEn.C - Measuring Input for Control	A, b, C, A-b, b-A, A-C, C-A, C-b, b-C	A		hidE	
↵[P074]Sen.S - Measuring Input for Presetting of Set Point	oFF, A, b, C	oFF		hidE	
↵[P075]oFF.A - Offset of Measuring Input A	-99.9...99.9	0.0		hidE	
↵[P076]oFF.b - Measurement range of Measuring Input B	0-10, 2-10	0		hidE	
↵[P077]oFF.C - Measurement range of Measuring Input C	0-20, 4-20	0		hidE	
↵[P078]Aib.L - Lower Display Limit of Measuring Input B	-100.0...1500.0	0.0		hidE	
↵[P079]Aib.H - Upper Display Limit of Measuring Input B	-100.0...1500.0	999.9		hidE	
↵[P080]AiC.L - Lower Display Limit of Measuring Input C	-100.0...1500.0	0.0		hidE	
↵[P081]AiC.H - Upper Display Limit of Measuring Input C	-100.0...1500.0	999.9		hidE	
↵[P082]A1.d1 - Alarm Flag 1, Definition 1	0...255	4		hidE	
↵[P083]A1.d2 - Alarm Flag 1, Definition 2	0...255	0		hidE	
↵[P084]A2.d1 - Alarm Flag 2, Definition 1	0...255	8		hidE	
↵[P085]A2.d2 - Alarm Flag 2, Definition 2	0...255	0		hidE	
↵[P086]A3.d1 - Alarm Flag 3, Definition 1	0...255	2		hidE	
↵[P087]A3.d2 - Alarm Flag 3, Definition 2	0...255	0		hidE	
↵[P088]A4.d1 - Alarm Flag 4, Definition 1	0...255	1		hidE	
↵[P089]A4.d2 - Alarm Flag 4, Definition 2	0...255	0		hidE	
↵[P090]t1.d1 - Mode of Operation of Timer 1, Definition 1	oFF, P.on, P.oFF, SP2.A, SP3.A, SP4.A, SP2.r, SP3.r, SP4.r, H.oFF, H.on, C.oFF, C.on	oFF		hidE	

Designation/characteristic analog mnemonic/parameter	Value range (physical value)	Standard	My Settings	Enabling	My enabling
↗[P091]t1.d2 - Mode of Operation of Timer 1, Definition 2	oFF,Auto, A.t1,A.t2,A.t3,A.t4,t1,t2,t3,t4, AL.t1,AL.t2,AL.t3,AL.t4,L.t1,L.t2,L.t3.L.t4,AL,L,AS,AS.t1,AS.t2,AS.t3,AS.t4	oFF		hidE	
↗[P092]t2.d1 - Mode of Operation of Timer 2, Definition 1	oFF, P.on, P.oFF, SP2.A, SP3.A, SP4.A, SP2.r, SP3.r, SP4.r, H.oFF, H.on, C.oFF, C.on	oFF		hidE	
↗[P093]t2.d2 - Mode of Operation of Timer 2, Definition 2	oFF,Auto, A.t1,A.t2,A.t3,A.t4,t1,t2,t3,t4, AL.t1,AL.t2,AL.t3,AL.t4,L.t1,L.t2,L.t3.L.t4,AL,L,AS,AS.t1,AS.t2,AS.t3,AS.t4	oFF		hidE	
↗[P094]t3.d1 - Mode of Operation of Timer 3, Definition 1	oFF, P.on, P.oFF, SP2.A, SP3.A, SP4.A, SP2.r, SP3.r, SP4.r, H.oFF, H.on, C.oFF, C.on	oFF		hidE	
↗[P095]t3.d2 - Mode of Operation of Timer 3, Definition 2	oFF,Auto, A.t1,A.t2,A.t3,A.t4,t1,t2,t3,t4, AL.t1,AL.t2,AL.t3,AL.t4,L.t1,L.t2,L.t3.L.t4,AL,L,AS,AS.t1,AS.t2,AS.t3,AS.t4	oFF		hidE	
↗[P096]t4.d1 - Mode of Operation of Timer 4, Definition 1	oFF, P.on, P.oFF, SP2.A, SP3.A, SP4.A, SP2.r, SP3.r, SP4.r, H.oFF, H.on, C.oFF, C.on	oFF		hidE	
↗[P097]t4.d2 - Mode of Operation of Timer 4, Definition 2	oFF,Auto, A.t1,A.t2,A.t3,A.t4,t1,t2,t3,t4, AL.t1,AL.t2,AL.t3,AL.t4,L.t1,L.t2,L.t3.L.t4,AL,L,AS,AS.t1,AS.t2,AS.t3,AS.t4	oFF		hidE	
↗[P098]t.rES - Mode of Operation of Timer after Soft-Reset	run, StoP, Auto	run		hidE	
↗[P099]Edit - Entry Mode Directly	oFF, on	on		hidE	
↗[P100]iLoc - Entry Lock on Info Level	oFF, on	oFF		hidE	
↗[P101]S.Adr - Address of serial interface	0...255	0		hidE	
↗[P102]S.Pro - Protocol of Serial Interface	PSG2, rtU,---	PSG2		hidE	
↗[P103]S.bd - Baud Rate of Serial Interface	1200, 2400, 4800, 9600, 19.2, 38.4	19.2		hidE	
↗[P104]S.Sto - Stop Bits of Serial Interface	1, 2	1		hidE	
↗[P105]S.PAr - Parity of Serial Interface	no, odd, EvEn	no		hidE	
↗[P106]C.bAS - CAN base address	0...127	32		hidE	
↗[P107]C.bd - CAN baud rate	78.8, 100, 125, 250, 500, 800, 1000	250		hidE	
↗[P108]C.OP - CAN Auto Operational Mode	oFF, Auto	Auto		hidE	
↗[P109]m.Adr - MODBUS address	0...255	1		hidE	
↗[P110]ULoc - Entry Lock on User/System level	0...100	0		hidE	

7.2 Firmware update

The firmware of the controller is continuously undergoing further development. Because the controller can be updated, the device can be maintained at the latest software after purchase. The controller firmware in the form of a file ("HEX- File") is clear of all charges.

The firmware is updated with the aid of the program WinKonVis (Art. No. 039020, executable from Microsoft Windows 98) over the serial interface RS485 (option).

The program as well as the controller firmware can be delivered on request on CD-ROM or per Email or directly be loaded from the homepage of Hotset GmbH.

For execution of the update there exist two interface converters SK232485 (Art. No. 039060, converter RS232-RS485) and SKUSB422 (Art. No. 039065, converter USB-RS485) as well as the dedicated adaptation cable VK4852DR (Art.No. 052220) as accessories.

Preparing update

- WinKonVis must be installed and licensed.
- Optional: Install the driver of the USB-RS485 interface converter from the disk supplied.
- Ensure that the interface connection between PC and controller functions (e.g. by interface test menu item Options/Interface/PSGII-Options in WinKonVis).

Execute update

Start WinKonVis and attach a project with a net-controller. The controller address of the attached controller must be identical with the address of the controller with which the firmware update should be carried out.

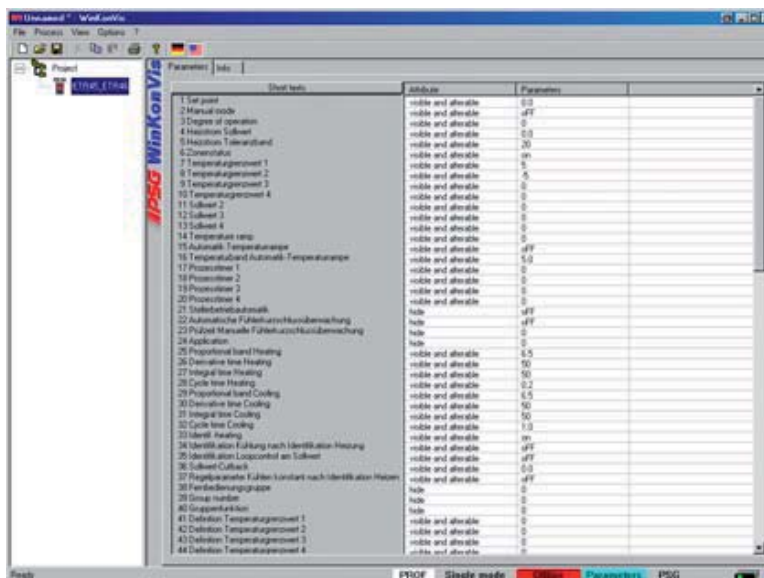

Click with right-hand mouse button on the controller in the left window. Select the firmware update menu item in the context menu.

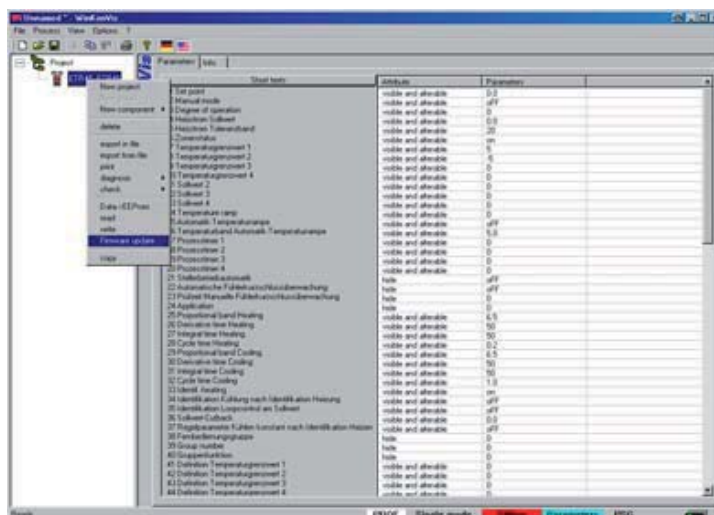

In the update dialog window the HEX file of the update firmware must first be selected.

For this purpose, click on the button "File" and select the last corresponding HEX file in the selection dialog box.

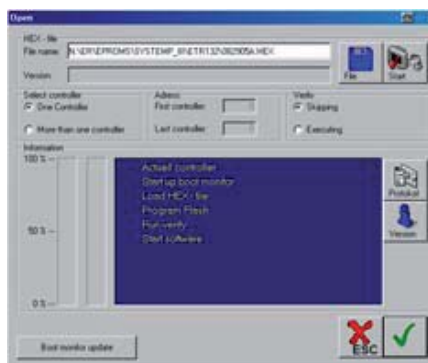

If the HEX file is damaged, then a warning appears. It is absolutely necessary to end the update procedure and provide a non-damaged HEX file.

Start firmware update through clicking on the button "Start".

A progress column displays the current status of the update procedure. The update process lasts about 4 minutes with deactivated verify function and with activated verify function about 7 minutes.

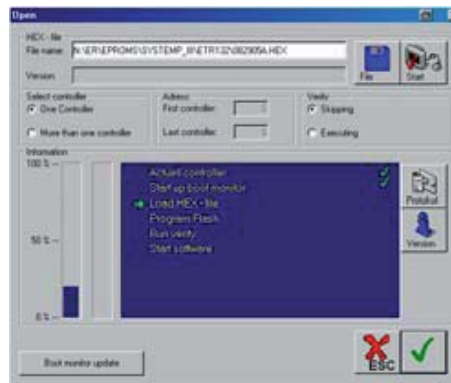
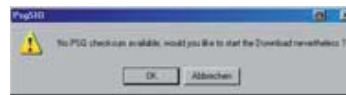

After successful firmware update, the controller is restarted. The dialog box can be closed.

7.3 Version History

Version	Date	Changes
1.01.08	5/12/2017	In detail the following amendments were made: <ul style="list-style-type: none"> ▪ Head office, logo ▪ [P073] graphics
1.01.07	7/6/2015	In detail the following amendments were made: <ul style="list-style-type: none"> ▪ Output cooling / alarm output 3 ▪ [P110] added ▪ Co.OP, Co.CL at [P058] added
1.01.06	5/28/2014	In detail the following amendments were made: <ul style="list-style-type: none"> ▪ Cross reference [P092] to [P097] new ▪ Info button / Escape button design changed
1.01.05	7/26/2013	In detail the following amendments were made: <ul style="list-style-type: none"> ▪ Analog outputs option A/B 0/2 VDC, 0/4 mA ▪ Configuration digital outputs adapted ▪ [P082] Change of Setpoint Value ▪ Correction of typing errors ▪ [P075], [P086], [P087] specified
1.01.04	02/05/2010	In detail the following amendments were made: <ul style="list-style-type: none"> ▪ Parameter number added [P***] ▪ Alarm hysteresis function added ([P041]...[P044], [P083], [P085], [P087], [P089])
1.01.03	05/20/2009	In detail the following amendments were made: <ul style="list-style-type: none"> ▪ Option A/B RS485 4-wire added ▪ Parameter OPt.A interface RS485 named rS ▪ Resulting address CAN corrected ▪ Example of application hot runner control added
1.01.02	05/08/2008	Functional extension S.C b and S.C C for parameter AO.A, AO.b. Specification for set-point of control for measuring input for presetting of set point (SEn.C). Set point of control scaled by parameter Aib.L, Aib.H, AiC.L, AiC.H. From software version 011308. Code number 211, 212 from software version 015107.
1.01.01	08/08/2007	Combination of keys for jump into system level revised (chapter 5.3, 5.3.4). Edit ON/OFF changed (chap. 5.3.5) Description of parameters t.rES, t*.d2 (chap. 6.9), Edit (chap. 6.10) specified. Update of parameter list in appendix.
...
Manufacturer/Supplier		Hotset GmbH Hueckstrasse 16 58511 Lüdenscheid Germany Tel. +49 23 51 43 02 - 0 Fax +49 23 51 43 02 - 25 www.hotset.com info@hotset.com